



saipwell  
斯普威尔

# Products Manual

## METAL ENCLOSURE 金属箱选型手册

金属箱选型手册  
Metal Enclosure Products Manual

**斯普威尔电气有限公司**  
SAIPWELL ELECTRIC CO.,LTD.

TEL: 0577-62760721

FAX: 0577-62760731

E-mail: info@saipwell.com

www.saipwell.com

浙江省温州市洞头区灵昆街道雁云路176号

No.176 Yanyun Road, Lingkun Street,

Dongtou District, Wenzhou, Zhejiang,China

**上海斯普威尔电气有限公司**  
SHANGHAI SAIPWELL ELECTRIC CO., LTD.

TEL: 021-33050667

FAX: 021-33050669

E-mail: info@saipwell.com

www.saipwell.com

上海市宝山区罗店路388弄10幢

No.10 Building, Lane 388, Luodian Road,

Baoshan District, Shanghai.

**赛普电气集团有限公司**  
SAIP ELECTRIC GROUP CO., LTD.

北京·上海·广州·温州·烟台·丽水  
Beijing · Shanghai · Guangzhou · Wenzhou · Yantai · Lishui

© 202604



Copyright © Saip ELEC. All Right Reserved  
Deliver happiness to everyone

# EQUIPMENT

专业设备 

SAIPWELL ELEC.

Copyright © SaipWell ELEC. All Right Reserved Deliver happiness to everyone

机器人焊接工艺是专业机柜生产不可或缺的，斯普威尔采用的机器人焊接包括顶底框型材焊接、小箱体焊接、门铰链及接地螺柱焊接。密封胶生产线使用了德国数控发泡技术，可确保密封胶条耐180度高温不硬化，沾漆不老化。斯普威尔拥有西门子数控系统、激光机、亚威冲剪复合机、机器人折弯机、福尼斯氩弧焊机和机器人激光焊接设备、静电喷涂线、台湾群昌自动包装机、拉丝机、打磨机，这些专业的技术生产设备保障了机柜的高质量输出与快速交付，为客户的交期负责是赛普的承诺。

The robotic welding process is essential in the production of professional cabinets, and Saipwell employs robotic welding techniques that cover welding of top and bottom frame profiles, welding of small enclosure bodies, welding of door hinges, and grounding screw welding. The sealing glue production line utilizes German CNC foaming technology to ensure that the sealing glue strip remains resistant to temperatures up to 180 degrees without hardening and does not age when exposed to paint.

Saipwell is equipped with Siemens CNC systems, laser machines, Yawei punching and shearing compound machines, robot bending machines, Fronius argon arc welding machines, robot laser welding equipment, electrostatic spraying lines, Taiwan Qunchang automatic packaging machines, wire drawing machines, polishing machines, and other specialized technical production equipment. These professional tools guarantee high-quality output and swift delivery of cabinets. Saipwell is committed to fulfilling its promise of being accountable for customer delivery schedules.



柔性钣金生产线 (FMS)



激光切割机



机器人焊接



螺柱焊接



密封胶设备

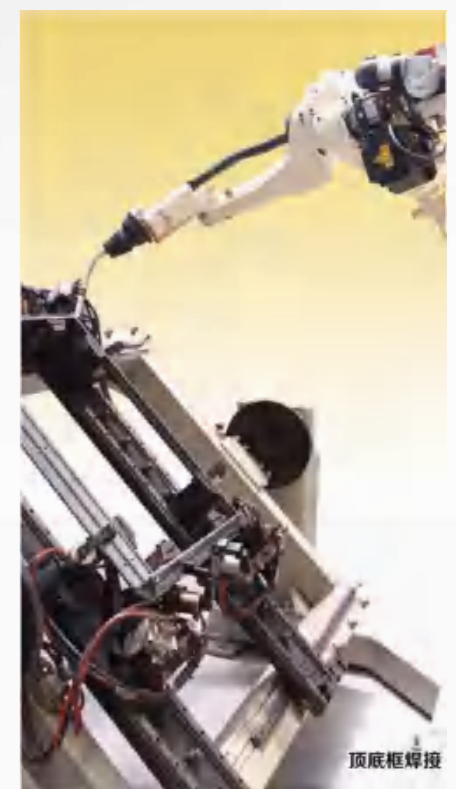

顶底框焊接

# INDUSTRY ENCLOSURES

## 工业机柜系列

前门后背板工业机柜

前门后门工业机柜



SAIP ELECT.

Copyright © Saip ELEC. All Right Reserved  
Deliver happiness to everyone



- 表面处理：纳米薄膜技术+阴极电泳技术+表面喷粉工艺
- 框架结构：9折型材框架，静态承重达到1000公斤  
16折型材框架，静态承重达到1500公斤
- 防护等级：IP55、IK08
- 开门方向：可随时变换门的开启方向，实现上下左右全面并柜
- 可选配置：冷轧钢板、不锈钢
- Surface Treatment: Nano-film technology + Cathodic electrophoretic coating technology + Powder coating process
- Frame Structure: 9-fold profile frame with a static load capacity of 1000 kg  
16-fold profile frame with a static load capacity of 1500 kg
- Protection Rating: IP55, IK08
- Flexible Door Opening Direction: The door opening direction can be adjusted at any time, allowing for full cabinet integration in all directions.
- Optional Configurations: Cold-rolled steel plate, stainless steel



### 产品特点 Features of Products

- 独立式全封闭构造，顶盖与各面一体成型，结合五折型材整体焊接框架，确保柜体高强度与优异稳定性
- 一体化焊接工艺显著提升密封效果，整柜防护等级可达 IP65
- 框架均布 25mm 模数安装孔，实现内部安装的高灵活性与广泛通用性
- 镀锌安装板采用导轨前端推入结构，配合 U 型折边加强设计，安装稳固、搬运便捷，并兼容 KP/KT 系列机柜系统

- Fully enclosed free-standing design with integrated top and side panels, combined with a welded 5-fold profile frame, ensuring high strength and excellent structural stability
- One-piece welding process enhances sealing performance, achieving a protection level up to IP66
- Frame features a 25mm pitch modular hole pattern, enabling flexible and universal internal installation
- Galvanized mounting plate adopts a front sliding rail insertion design with reinforced U-shaped edges, ensuring secure installation and easy handling, compatible with KP and KT cabinet systems

### KD 系列订货规格表

#### KD series order specification table

\*可定制非标产品  
Nonstandard products are customizable

序号 No.	订货号(KD) Order number (RAL7032)	订货号(KD) Order number (RAL7035)	宽 Width	高 Height	深 Depth
1	KD601640102	KD601640105	600	1600	400
2	KD601650102	KD601650105	600	1600	500
3	KD601840102	KD601840105	600	1800	400
4	KD601850102	KD601850105	600	1800	500
5	KD602050102	KD602050105	600	2000	500
6	KD602060102	KD602060105	600	2000	600
7	KD801450102	KD801450105	800	1400	500
8	KD801650102	KD801650105	800	1600	500
9	KD801840102	KD801840105	800	1800	400
10	KD801850102	KD801850105	800	1800	500
11	KD801880102	KD801880105	800	1800	800
12	KD802050102	KD802050105	800	2000	500
13	KD802060102	KD802060105	800	2000	600
14	KD802080102	KD802080105	800	2000	800
15	KD802260102	KD802260105	800	2200	600
16	KD101840112	KD101840115	1000	1800	400
17	KD121450112	KD121450115	1200	1400	500
18	KD121650112	KD121650115	1200	1600	500
19	KD121840112	KD121840115	1200	1800	400
20	KD121850112	KD121850115	1200	1800	500
21	KD122050112	KD122050115	1200	2000	500
22	KD122060112	KD122060115	1200	2000	600
23	KD122260112	KD122260115	1200	2200	600

材料 Material	冷轧钢板 Cold-roll steel sheet
表面处理 Surface treatment	机柜磷化底涂处理，外部为粉末涂层，颜色可分RAL7032和RAL7035两种织纹，安装板则为镀锌 Cabinet is applied with etch primer and covered with powder coating on the outer side. Two color textures, RAL7032 and RAL7035, are available. The mounting plate is galvanized.
防护等级 Protection	IP65 (符合IEC 60529) NAME 4 IP65 (Acc to IEC 60529) NAME 4
标准配置 Standard configuration	前门、背板、安装板、柜体、门锁、密封条 Front door, back plate, mounting plate, cabinet, door lock, sealing strip
钢板厚度 Plate thickness	框架：五折型材1.5mm 门板：2.0mm 背板：1.5mm 安装板：2.5mm Frame: 5-fold sections 1.5mm Door plate: 2.0mm Back plate: 1.5mm Mounting plate: 2.5mm





材料 Material	SUS304 (其它材料型号可选) SUS304 (other material types are optional)
表面处理 Surface treatment	拉丝, 安装板则为镀锌 Wire drawing, and mounting plate is galvanized
防护等级 Protection	IP65 (符合IEC 60529) NAME 4 IP65 (Acc to IEC 60529) NAME 4
标准配置 Standard configuration	前门、背板、安装板、柜体、门锁、密封条 Front door, back plate, mounting plate, cabinet, door lock, sealing strip
钢板厚度 Plate thickness	框架: 五折型材1.5mm 门板: 2.0mm 背板: 1.5mm 安装板: 2.5mm Frame: 5-fold sections 1.5mm Door plate: 2.0mm Back plate: 1.5mm Mounting plate: 2.5mm



KD不锈钢系列订货规格表

KD Stainless steel series order specification table

\*可定制非标产品  
Nonstandard products are customizable

序号 No.	订货号(BKD) Order number (BKD)	宽 Width	高 Height	深 Depth
1	KD60164010S	600	1600	400
2	KD60165010S	600	1600	500
3	KD60184010S	600	1800	400
4	KD60185010S	600	1800	500
5	KD60205010S	600	2000	500
6	KD60206010S	600	2000	600
7	KD80145010S	800	1400	500
8	KD80165010S	800	1600	500
9	KD80184010S	800	1800	400
10	KD80185010S	800	1800	500
11	KD80188010S	800	1800	800
12	KD80205010S	800	2000	500
13	KD80206010S	800	2000	600
14	KD80208010S	800	2000	800
15	KD80226010S	800	2200	600
16	KD10184011S	1000	1800	400
17	KD12145011S	1200	1400	500
18	KD12165011S	1200	1600	500
19	KD12184011S	1200	1800	400
20	KD12185011S	1200	1800	500
21	KD12205011S	1200	2000	500
22	KD12206011S	1200	2000	600
23	KD12226011S	1200	2200	600

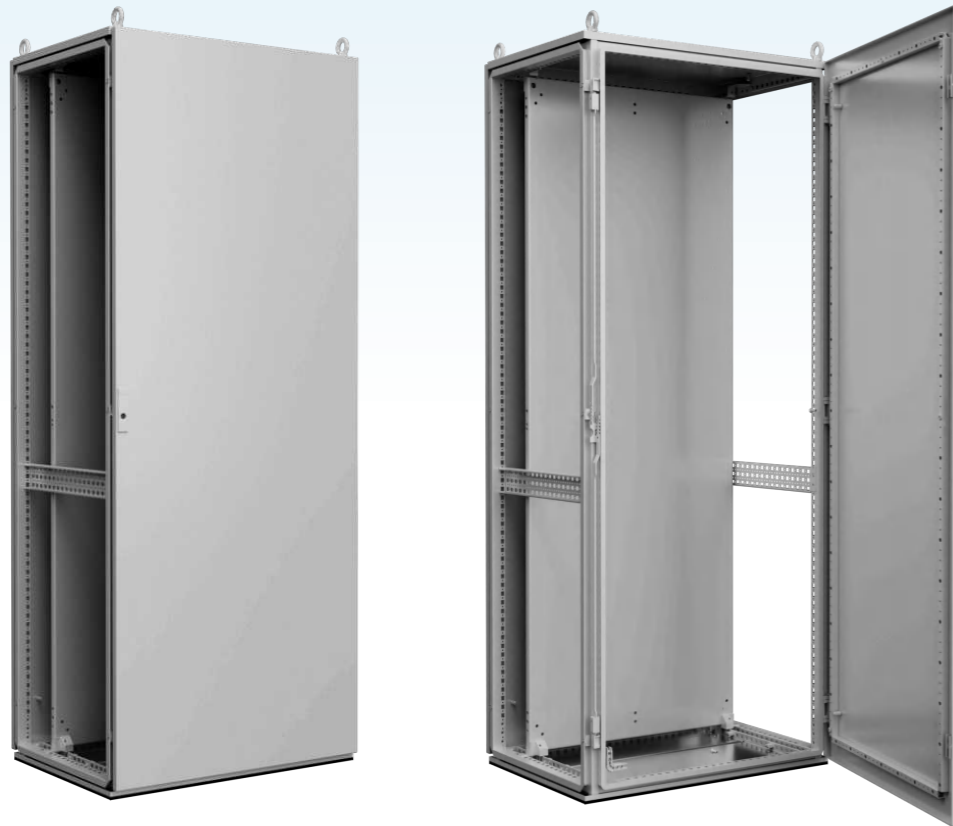

产品特点 Features of Products

- 模块化设计的电柜，可以并联使用
- 独特的拼装结构（也可以选择焊接整装出货），既保证了电柜的尺寸精度和承重性能，又成倍地节约了仓储和运输的空间和成本
- 顶板、侧板和后背板可以拆除，易于工作
- 门板离地高度达到25mm，确保开门灵活顺畅
- 可拆卸的门机板加强筋，方便灵活
- 框架结构有符合国际惯例的25mm间距的模数孔，通用性强安装方便灵活
- 滑入式结构的安装板，方便操作和搬运

- Module industrial enclosure, bayable to left and right without limitation
- The unique knockdown structure reduce about 70% storagage space and delivery cost by flat packing (Option: Welded assembly shipment)
- Every enclosure, accessible from all sides, give easy and comforte to the operators
- The distance between the down edge of the door and the floor is 25 mm
- The door can be open and closed smoothly at any condior
- Movable door frame with holes on 25 mm pitch pattern can reinforce the door and give more possibilities for different application
- After installation, mounting plate can be slided in easily

框架安装  
Frame mounting

安装工具

M5梅花批头、手电钻

将四根纵梁如图方向插入前后框架，使用梅花槽沉头三角锁紧螺钉M5×20对孔固定。

Installation tool

1. M5 Torx screwdriver bit and hand drill

2. Insert the four longitudinal beams into the front and rear frames in the orientation shown in the diagram, and secure them through the aligned holes using M5×20 countersunk Torx triangular locking screws.

材料 Material	冷轧板 (其他材料可选) Cold rolled plate (other material are optional)
表面处理 Surface treatment	喷塑、小桔纹、RAL7035 Powder-coated in textured RAL 7035
防护等级 Protection	IP55 (符合IEC 60529) NAME 12 (Type12) IP55 (Acc to IEC 60529) NAME 12 (Type12)
标准配置 Standard configuration	柜体框架、门、安装板、后背板、顶、底 (侧板和底座另选) Frame, front door, mounting plate, rear panel, roof plate, gland plates (Side Wall and Base optional)
钢板厚度 Plate thickness	框架: 九折型材1.5mm 门板: 2.0mm 背板、侧板: 1.5mm 安装板: 2.5mm Frame: 1.5mm Door: 2.0mm Mounting plate: 2.5mm Others: 1.5mm
认证证书 Certification	



平板包装，节约仓储空间和运输成本70%  
Flat-packing can save 70% delivery costs



创新的拼装结构，牢固、易安装  
Unique knockdown structure – stable and easy to install

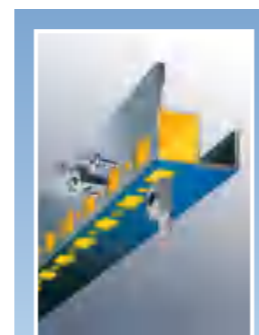

兼容PS和TS并柜系统的标准技术  
Alternative enclosure of PS and TS baying system

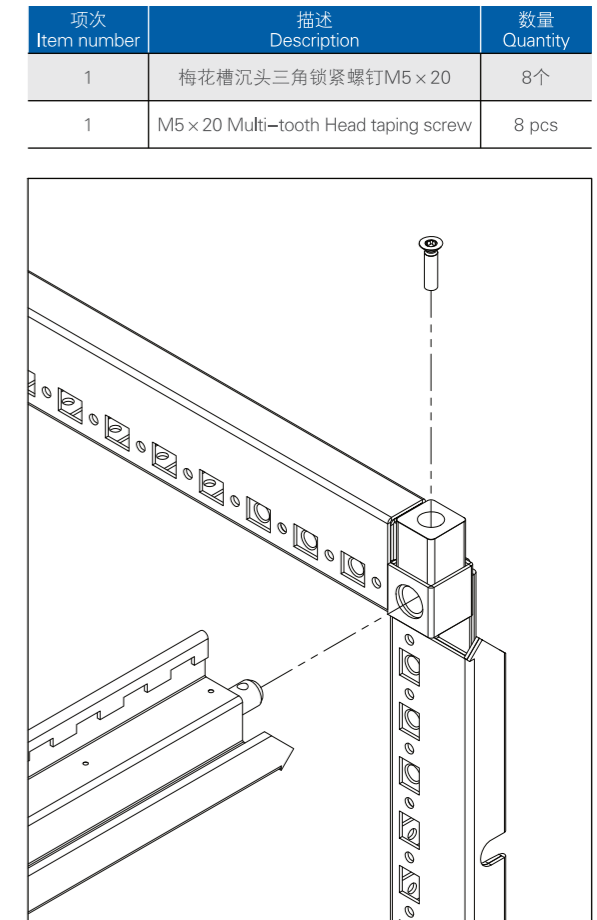
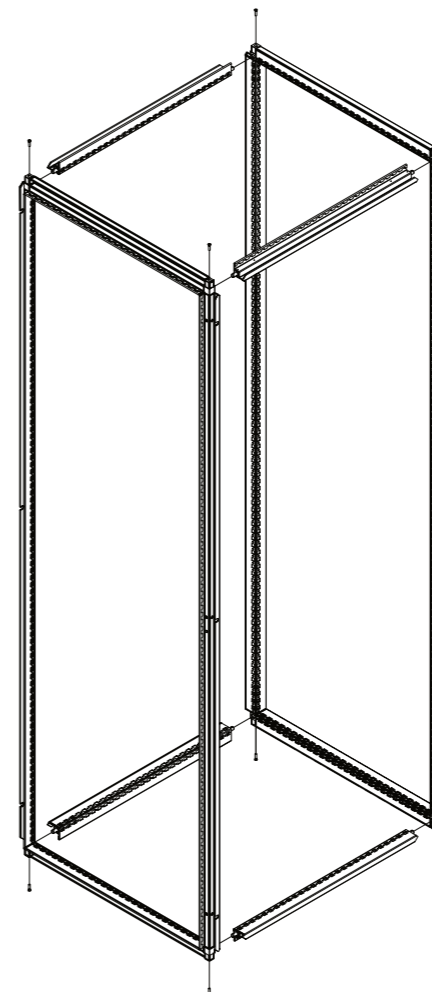



KP系列订货规格表

List of specification of KP enclosures

\*可定制非标产品  
Nonstandard products are customizable

序号 No.	类别 Category	订货号 Order No.	宽 Width (mm)	高 Height (mm)	深 Depth (mm)	供货范围 Supply Includes
1	整柜散装 Complete Enclosure (Flat Packing)	KP601650005	600	1600	500	包括: 前后框2个, 框架深度梁4根, 单开门1扇, 后板1块, 顶板1块, 运输吊环4个, 三段式底板1套, 安装板1块。  Includes: 2 front/rear frames, 4 depth beams, 1 single door, 1 rear wall, 1 roof, 4 eye-bolt, 1 bottom, 1 mounting plate. RAL 7035
2		KP601850005	600	1800	500	
3		KP601860005	600	1800	600	
4		KP602040005	600	2000	400	
5		KP602050005	600	2000	500	
6		KP602060005	600	2000	600	
7		KP602080005	600	2000	800	
8		KP802260005	600	2200	600	
9		KP801450005	800	1400	500	
10		KP801650005	800	1600	500	
11		KP801850005	800	1800	500	
12		KP801860005	800	1800	600	
13		KP801880005	800	1800	800	
14		KP802050005	800	2000	500	
15		KP802060005	800	2000	600	
16		KP802080005	800	2000	800	
17		KP802260005	800	2200	600	
18		KP102050015	1000	2000	500	
19		KP102060015	1000	2000	600	
20		KP121450015	1200	1400	500	
21		KP121840015	1200	1800	400	
22		KP121850015	1200	1800	500	
23		KP121860015	1200	1800	600	
24		KP122040015	1200	2000	400	
25		KP122050015	1200	2000	500	
26		KP122060015	1200	2000	600	
27		KP122080015	1200	2000	800	
28	KP122260015	1200	2200	600		
29	整柜整装 Complete Enclosure (Full Assembled)	KP601650105	600	1600	500	包括: 箱体框架1套, 单开门1扇, 后板1块, 顶板1块, 运输吊环4个, 三段式底板1套, 安装板1块。  Includes: 1 Enclosure frame, 1 single door, 1 rear wall, 1 roof, 4 eye-bolt, 1 bottom, 1 mounting plate. RAL 7035
30		KP601850105	600	1800	500	
31		KP601860105	600	1800	600	
32		KP602040105	600	2000	400	
33		KP602050105	600	2000	500	
34		KP602060105	600	2000	600	
35		KP602080105	600	2000	800	
36		KP602260105	600	2200	600	
37		KP801450105	800	1400	500	
38		KP801650105	800	1600	500	
39		KP801850105	800	1800	500	
40		KP801860105	800	1800	600	
41		KP801880105	800	1800	800	
42		KP802050105	800	2000	500	
43		KP802060105	800	2000	600	
44		KP802080105	800	2000	800	
45		KP802260105	800	2200	600	
46		KP102050115	1000	2000	500	
47		KP102060115	1000	2000	600	
48		KP121450115	1200	1400	500	
49		KP121840115	1200	1800	400	
50		KP121850115	1200	1800	500	
51		KP121860115	1200	1800	600	
52		KP122040115	1200	2000	400	
53		KP122050115	1200	2000	500	
54		KP122060115	1200	2000	600	
55		KP122080115	1200	2000	800	
56	KP122260115	1200	2200	600		
57	侧板 Side Wall	KPSW1650005	SW	1400	500	包括: 侧板2块, 安装附件A 1套 (侧板固定件12个, ST6.3*18 螺钉12颗)  Includes: 2 side walls, 1 set of A-type fixture accessories ( 12 fixtures, 12 ST6.3x18 Phillip- head Screws).
58		KPSW1650005	SW	1600	500	
59		KPSW1840005	SW	1800	400	
60		KPSW1850005	SW	1800	500	
61		KPSW1860005	SW	1800	600	
62		KPSW1880005	SW	1800	800	
63		KPSW2040005	SW	2000	400	
64		KPSW2050005	SW	2000	500	
65		KPSW2060005	SW	2000	600	
66		KPSW2080005	SW	2000	800	
67	KPSW2260005	SW	2200	600		



KP系列订货规格表

List of specification of KP enclosures

\*可定制非标产品  
Nonstandard products are customizable

序号 No.	类别 Category	订货号 Order No.	宽 Width (mm)	高 Height (mm)	深 Depth (mm)	供货范围 Supply Includes
1	安装板 Mounting_Plate	KP6016MP005	600	1600	MP	包括: 安装板1块, 安装附件E 1套, 镀锌板  Includes: 1 mounting plate, 1 set E-type of fixture accessories, Zinc plated
2		KP6018MP005	600	1800	MP	
3		KP6020MP005	600	2000	MP	
4		KP6022MP005	600	2200	MP	
5		KP8014MP005	800	1400	MP	
6		KP8016MP005	800	1600	MP	
7		KP8018MP005	800	1800	MP	
8		KP8020MP005	800	2000	MP	
9		KP8022MP005	800	2200	MP	
10		KP1018MP005	1000	1800	MP	
11		KP1020MP005	1000	2000	MP	
12		KP1214MP005	1200	1400	MP	
13		KP1218MP005	1200	1800	MP	
14		KP1220MP005	1200	2000	MP	
15		KP1222MP005	1200	2200	MP	
16	门 Door	KP6016DS005	600	1600	DS	包括: 小型平面锁1把, 铰链3个, 锁杆1对, 锁挡块2个, 锁舌1片。  Includes: 1 small falt lock, 3 hing, 1 pair of lock rod, 2 lock hock, 1 lock plate.
17		KP6018DS005	600	1800	DS	
18		KP6020DS005	600	2000	DS	
19		KP6022DS005	600	2200	DS	
20		KP8014DS005	800	1400	DS	
21		KP8016DS005	800	1600	DS	
22		KP8018DS005	800	1800	DS	
23		KP8020DS005	800	2000	DS	
24		KP8022DS005	800	2200	DS	
25		KP1018DD005	1000	1800	DD	
26		KP1020DD005	1000	2000	DD	
27		KP1214DD005	1200	1400	DD	
28		KP1218DD005	1200	1800	DD	
29		KP1220DD005	1200	2000	DD	
30		KP1222DD005	1200	2200	DD	
31	后板 Rear Wall	KP6016RW005	600	1600	RW	包括: 后板1块, 安装附件C 1套(背板固定件6个 M6*10内六角螺丝6颗, M6*16螺丝6颗)。  Includes: 1 rear wall, 1 set of C-type fixture accessories ( 6 Real Plate Fixtures, 6 M6x10 AllenHead Screws, 6 M6x16 Phillip-headScrews).
32		KP6018RW005	600	1800	RW	
33		KP6020RW005	600	2000	RW	
34		KP6022RW005	600	2200	RW	
35		KP8014RW005	800	1400	RW	
36		KP8016RW005	800	1600	RW	
37		KP8018RW005	800	1800	RW	
38		KP8020RW005	800	2000	RW	
39		KP8022RW005	800	2200	RW	
40		KP1018RW005	1000	1800	RW	
41		KP1020RW005	1000	2000	RW	
42		KP1214RW005	1200	1400	RW	
43		KP1218RW005	1200	1800	RW	
44		KP1220RW005	1200	2000	RW	
45		KP1222RW005	1200	2200	RW	
46	前后框 Front/Rear Frame	KP6016FF005	600	1600	FF	包括: 前后框架2个 Includes: 2 frames
47		KP6018FF005	600	1800	FF	
48		KP6020FF005	600	2000	FF	
49		KP6022FF005	600	2200	FF	
50		KP8014FF005	800	1400	FF	
51		KP8016FF005	800	1600	FF	
52		KP8018FF005	800	1800	FF	
53		KP8020FF005	800	2000	FF	
54		KP8022FF005	800	2200	FF	
55		KP1018FF005	1000	1800	FF	
56		KP1020FF005	1000	2000	FF	
57		KP1214FF005	1200	1400	FF	
58		KP1218FF005	1200	1800	FF	
59		KP1220FF005	1200	2000	FF	
60		KP1222FF005	1200	2200	FF	
61	框架深度梁 Depth Beam	KPFD40005	FD	FD	400	包括: 框架深度梁4根, M5*20螺丝8颗。 Includes: 4 beams and 8 pieces of M5X20 screw.
62		KPFD50005	FD	FD	500	
63		KPFD60005	FD	FD	600	
64		KPFD80005	FD	FD	800	



材料 Material	SUS304 (其它材料型号可选) SUS304 (other material types are optional)
表面处理 Surface treatment	拉丝, 安装板则为镀锌 Wire drawing, and mounting plate is galvanized
防护等级 Protection	IP55 (符合IEC 60529) NAME 12 (Type12) IP55 (Acc to IEC 60529) NAME 12 (Type12)
标准配置 Standard configuration	前门、背板、安装板、柜体、密封条、门锁、侧板(可选件) Front door, back plate, mounting plate, cabinet body, sealing strip, door lock and side plate (optional)
钢板厚度 Plate thickness	框架: 九折型材1.5mm 门板: 2.0mm 背板、侧板: 1.5mm 安装板: 2.5mm Frame: nine-fold section 1.5mm Door plate: 2.0mm Back plate and side plate: 1.5mm Mounting plate: 2.5mm
认证证书 Certification	

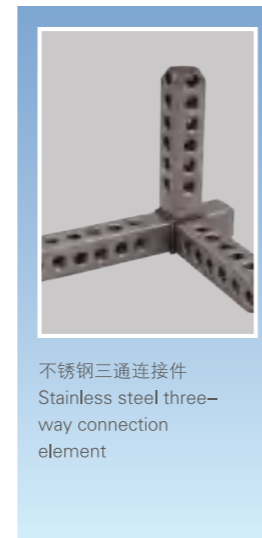

KP不锈钢系列订货规格表

KP Stainless steel series order specification table

\*可定制非标产品  
Nonstandard products are customizable

序号 No.	类别 Category	订货号 Order No.	宽 Width (mm)	高 Height (mm)	深 Depth (mm)	供货范围 Supply Includes
1	整柜散装 Complete Enclosure (Flat Packing)	KP60165000S	600	1600	500	包括: 前后框2个, 框架深度梁4根, 单开门1扇, 后板1块, 顶板1块, 运输吊环4个, 三段式底板1套, 安装板1块。  Includes: 2 front/rear frames, 4 depth beams, 1 single door, 1 rear wall, 1 roof, 4 eye-bolt, 1 bottom, 1 mounting plate. RAL 7035
2		KP60185000S	600	1800	500	
3		KP60186000S	600	1800	600	
4		KP60204000S	600	2000	400	
5		KP60205000S	600	2000	500	
6		KP60206000S	600	2000	600	
7		KP60208000S	600	2000	800	
8		KP60226000S	600	2200	600	
9		KP80145000S	800	1400	500	
10		KP80165000S	800	1600	500	
11		KP80185000S	800	1800	500	
12		KP80186000S	800	1800	600	
13		KP80188000S	800	1800	800	
14		KP80205000S	800	2000	500	
15		KP80206000S	800	2000	600	
16		KP80208000S	800	2000	800	
17		KP80226000S	800	2200	600	
18		KP10205001S	1000	2000	500	
19		KP10206001S	1000	2000	600	
20		KP12145001S	1200	1400	500	
21		KP12184001S	1200	1800	400	
22		KP12185001S	1200	1800	500	
23		KP12186001S	1200	1800	600	
24		KP12204001S	1200	2000	400	
25		KP12205001S	1200	2000	500	
26		KP12206001S	1200	2000	600	
27		KP12208001S	1200	2000	800	
28	KP12226001S	1200	2200	600		
29	整柜整装 Complete Enclosure (Full Assembled)	KP60165010S	600	1600	500	包括: 箱体框架1套, 单开门1扇, 后板1块, 顶板1块, 运输吊环4个, 三段式底板1套, 安装板1块。  Includes: 1 Enclosure frame, 1 single door, 1 rear wall, 1 roof, 4 eye-bolt, 1 bottom, 1 mounting plate. RAL 7035
30		KP60185010S	600	1800	500	
31		KP60186010S	600	1800	600	
32		KP60204010S	600	2000	400	
33		KP60205010S	600	2000	500	
34		KP60206010S	600	2000	600	
35		KP60208010S	600	2000	800	
36		KP60226010S	600	2200	600	
37		KP80145010S	800	1400	500	
38		KP80165010S	800	1600	500	
39		KP80185010S	800	1800	500	
40		KP80186010S	800	1800	600	
41		KP80188010S	800	1800	800	
42		KP80205010S	800	2000	500	
43		KP80206010S	800	2000	600	
44		KP80208010S	800	2000	800	
45		KP80226010S	800	2200	600	
46		KP10205011S	1000	2000	500	
47		KP10206011S	1000	2000	600	
48		KP12145011S	1200	1400	500	
49		KP12184011S	1200	1800	400	
50		KP12185011S	1200	1800	500	
51		KP12186011S	1200	1800	600	
52		KP12204011S	1200	2000	400	
53		KP12205011S	1200	2000	500	
54		KP12206011S	1200	2000	600	
55		KP12208011S	1200	2000	800	
56	KP12226011S	1200	2200	600		
57	侧板 Side Wall	KPSW165000S	SW	1400	500	包括: 侧板2块, 安装附件A 1套 (侧板固定件12个, ST6.3*18 螺钉12颗)  Includes: 2 side walls, 1 set of A-type fixture accessories ( 12 fixtures, 12 ST6.3x18 Phillip-head Screws).
58		KPSW165000S	SW	1600	500	
59		KPSW184000S	SW	1800	400	
60		KPSW185000S	SW	1800	500	
61		KPSW186000S	SW	1800	600	
62		KPSW188000S	SW	1800	800	
63		KPSW204000S	SW	2000	400	
64		KPSW205000S	SW	2000	500	
65		KPSW206000S	SW	2000	600	
66		KPSW208000S	SW	2000	800	
67	KPSW226000S	SW	2200	600		

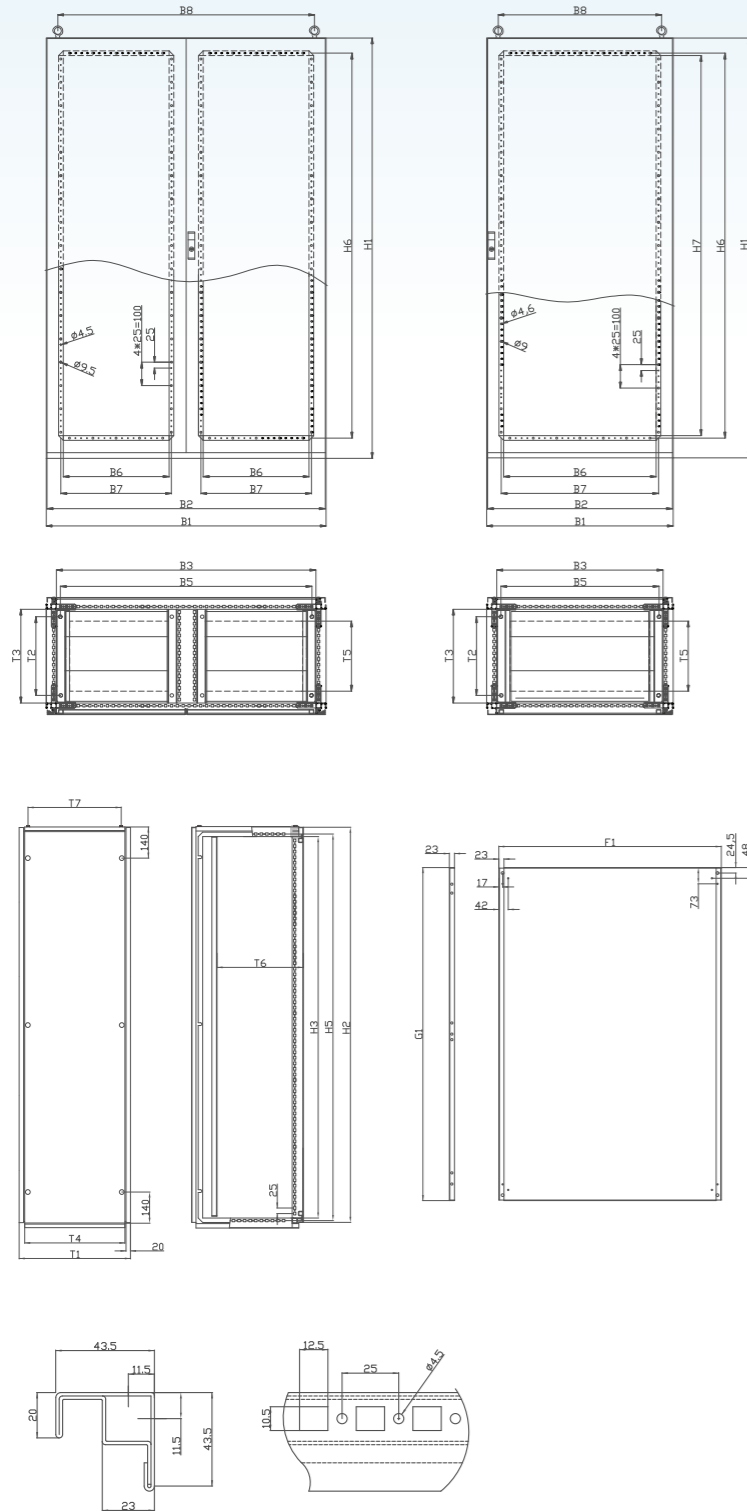

- B1: 总宽度  
(不含侧板, 框架外圈尺寸)
- B2: 门的宽度
- B3: 箱体框架内的净宽度
- B5: 柜体下纵梁与底板对应孔  
(无底座, 此孔与地面相连接)
- B6: 门板后部方管加强筋左右侧内档距离
- B7: 门板后部方管加强筋左右侧中心距离
- B8: 两个吊环之间的距离
- B9: 箱底开缝宽度
- T1: 总深度
- T2: 底板与地面固定物前后连接孔.
- T3: 底框内的净深度
- T4: 底框深度
- T5: 箱底开缝的深度
- T6: 安装板深度, 从149mm开始以每格25mm的距离进行调节
- T7: 两个吊环中心点之间的距离
- H1: 总高度
- H2: 门和后背板的高度
- H3: 箱底框架内的净高度
- H5: 框架上下横型材梁之间的高度
- H6: 门板后部方管加强筋上下侧中心距离
- H7: 门板后部方管加强筋上下侧内档距离

- F: 安装板的总宽度
- G: 安装板的总高度
- B1: Total width (Excluding the lateral plate, the outer frame size)
- B2: Door width
- B3: Net width of the cabinet inner frame
- B5: Corresponding hole of longitudinal beam beneath cabinet and bottom plate(Without base, this hole connected to the ground)
- B6: The left and right interior distance of the square tube reinforcing rib installation in the back of door plate
- B7: The left and right center distance of the square tube reinforcing rib in the back of door plate
- B8: The distance between the two rings
- B9: Cabinet bottom slit width
- T1: Total depth
- T2: The front and back connection holes for the fixation of the Bottom plate and ground
- T3: Net depth in the bottom frame
- T4: Depth of the bottom frame
- T5: Depth of the slit in the cabinet bottom
- T6: Mounting plate depth, the adjustment is from the beginning of the 149 mm in per 25 mm distance.
- T7: The distance between the center of the two rings
- H1: Total height
- H2: The height of the door and back plate
- H3: The net height in the frame of the cabinet bottom
- H5: The height of the upper and lower landscape Shaped beam of the frame
- H6: The left and right center distance of the square tube reinforcing rib in the back of door plate
- H7: The left and right interior distance of the square tube reinforcing rib in the back of door plate
- F: Mounting plate width
- G: Mounting plate height

\*B1 : 宽度 ≥ 1200 时, 底部进线板结构分左右 2 部分。  
\*B1: ≥1200 width, the bottom line board structure at around 2 parts.

规格尺寸 Dimension			宽度 Width							高度 Height							深度 Depth							安装板 Mounting Plate	
宽 Width	高 Height	深 Depth	B1	B2	B3	B5	B6	B7	B8	B9	H1	H2	H3	H5	H6	H7	T1	T2	T3	T4	T5	T6	T7	F	G
600	1600	500	599	592	512	478	454	474	535	400	1600	1575	1512	1535	1450	1430	500	335	402	450	300	449	425	1496	498
600	1800	400	599	592	512	478	454	474	535	400	1800	1775	1712	1735	1650	1630	400	235	302	350	200	349	325	498	1696
600	1800	500	599	592	512	478	454	474	535	400	1800	1775	1712	1735	1650	1630	500	335	402	450	300	449	425	498	1696
600	1800	600	599	592	512	478	454	474	535	400	1800	1775	1712	1735	1650	1630	600	435	502	550	400	549	525	498	1696
600	2000	400	599	592	512	478	454	474	535	400	2000	1975	1912	1935	1850	1830	400	235	302	350	200	349	325	498	1896
600	2000	500	599	592	512	478	454	474	535	400	2000	1975	1912	1935	1850	1830	500	335	402	450	300	449	425	498	1896
600	2000	600	599	592	512	478	454	474	535	400	2000	1975	1912	1935	1850	1830	600	435	502	550	400	549	525	498	1896
600	2000	800	599	592	512	478	454	474	535	400	2000	1975	1912	1935	1850	1830	800	635	702	750	600	749	725	498	1896
600	2200	600	599	592	512	478	454	474	535	400	2200	2175	2112	2135	2050	2030	600	435	502	550	400	549	525	498	2096
800	1400	500	799	792	712	678	654	674	735	600	1400	1375	1312	1335	1250	1230	500	335	402	450	300	449	425	1296	698
800	1600	500	799	792	712	678	654	674	735	600	1600	1575	1512	1535	1450	1430	500	335	402	450	300	449	425	1496	698
800	1800	400	799	792	712	678	654	674	735	600	1800	1775	1712	1735	1650	1630	400	235	302	350	200	349	325	698	1696
800	1800	500	799	792	712	678	654	674	735	600	1800	1775	1712	1735	1650	1630	500	335	402	450	300	449	425	698	1696
800	1800	600	799	792	712	678	654	674	735	600	1800	1775	1712	1735	1650	1630	600	435	502	550	400	549	525	698	1696
800	2000	400	799	792	712	678	654	674	735	600	2000	1975	1912	1935	1850	1830	400	235	302	350	200	349	325	698	1896
800	2000	500	799	792	712	678	654	674	735	600	2000	1975	1912	1935	1850	1830	500	335	402	450	300	449	425	698	1896
800	2000	600	799	792	712	678	654	674	735	600	2000	1975	1912	1935	1850	1830	600	435	502	550	400	549	525	698	1896
800	2000	800	799	792	712	678	654	674	735	600	2000	1975	1912	1935	1850	1830	800	635	702	750	600	749	725	698	1896
800	2200	600	799	792	712	678	654	674	735	600	2200	2175	2112	2135	2050	2030	600	435	502	550	400	549	525	698	2096
1000	1800	400	999	992	912	878	854	874	935	800	1800	1775	1712	1735	1650	1630	400	235	302	350	200	349	325	898	1696
1000	2000	500	999	992	912	878	854	874	935	800	2000	1975	1912	1935	1850	1830	500	335	402	450	300	449	425	898	1896
1000	2000	600	999	992	912	878	854	874	935	800	2000	1975	1912	1935	1850	1830	600	435	502	550	400	549	525	898	1896
1200	1400	500	1199	1192	1112	1078	1054	1074	1135	1000	1400	1375	1312	1335	1250	1230	500	335	402	450	300	449	425	1296	1098
1200	1800	400	1199	1192	1112	1078	1054	1074	1135	1000	1800	1775	1712	1735	1650	1630	400	235	302	350	200	349	325	1098	1696
1200	1800	500	1199	1192	1112	1078	1054	1074	1135	1000	1800	1775	1712	1735	1650	1630	500	335	402	450	300	449	425	1098	1696
1200	1800	600	1199	1192	1112	1078	1054	1074	1135	1000	1800	1775	1712	1735	1650	1630	600	435	502	550	400	549	525	1098	1696
1200	2000	400	1199	1192	1112	1078	1054	1074	1135	1000	2000	1975	1912	1935	1850	1830	400	235	302	350	200	349	325	1098	1896
1200	2000	500	1199	1192	1112	1078	1054	1074	1135	1000	2000	1975	1912	1935	1850	1830	500	335	402	450	300	449	425	1098	1896
1200	2000	600	1199	1192	1112	1078	1054	1074	1135	1000	2000	1975	1912	1935	1850	1830	600	435	502	550	400	549	525	1098	1896
1200	2000	800	1199	1192	1112	1078	1054	1074	1135	1000	2000	1975	1912	1935	1850	1830	800	635	702	750	600	749	725	1098	1896
1200	2200	600	1199	1192	1112	1078	1054	1074	1135	1000	2200	2175	2112	2135	2050	2030	600	435	502	550	400	549	525	1098	2096



材料 Material	冷轧钢板 Cold-roll steel sheet
表面处理 Surface treatment	机柜磷化底涂处理，外部为粉末涂层，颜色可分RAL7032和RAL7035两种织纹，安装板则为镀锌 Cabinet is applied with etch primer and covered with powder coating on the outer side. Two color textures, RAL7032 and RAL7035, are available. The mounting plate is galvanized.
防护等级 Protection	IP55 (符合IEC 60529) NAME 12 (Type12) IP55 (Acc to IEC 60529) NAME 12 (Type12)
标准配置 Standard configuration	前门、背板、安装板、柜体、密封条、门锁、侧板(可选) Front door, back plate, mounting plate, cabinet body, sealing strip, door lock and side plate (optional)
钢板厚度 Plate thickness	框架：十六折型材1.5mm 门板：2.0mm 背板、侧板：1.5mm 安装板：2.5mm Frame: TS profile 1.5mm Door plate: 2.0mm Back plate and side plate: 1.5mm Mounting plate: 2.5mm
认证证书 Certification	



柜体的垂直剖面采用了十六折型材，不仅提供了两层安装平面而且将安装空间利用率提高了15%  
The 16-fold profile of the vertical sections is the key to an intelligent two-level concept, which not only provides a second mounting level as standard, but also offers up to 15% more installation space in the enclosure.

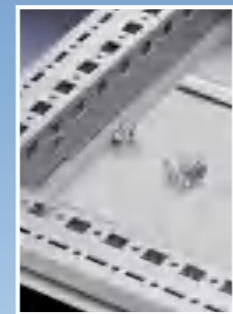

通过在框架和所有面板之间进行导电连接，机柜装配完成后，盖板、侧板、后板、顶盖将自动实现电势平衡。  
Potential equalisation for the gland plates, side panels, rear panel and roof is achieved automatically when the enclosure is assembled. That guarantees a conductive contact between the frame and all panel parts.

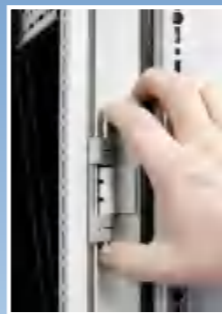

门铰链无需任何机械改装即可切换到另一侧  
The door hinge can be switched to the other side with no mechanical modification.

产品特点 Features of Products

- 由于完全对称的框架截面，使用附件时具有完全的灵活性，宽度和深度的附件相同
- 四面都可以并柜
- 门铰链可以轻松互换到另外的一侧，无需再加工。
- 通过所有外壳面板和法兰盘组件实现自动电位均衡
- 具有高达1500kg的高承载能力
- 安装板能简单快速安装。固定滑块可以在侧框内自由安装和拆卸。

- Full flexibility with the use of accessories, thanks to a fully symmetrical frame section. With identical accessories for the width and depth
- Bayable on all sides
- Door hinge is easily swapped to the opposite side without machining
- Automatic potential equalisation via the assembly components with all enclosure panels and gland plates
- Enclosure has a high load-bearing capacity of up to 1500 kg
- Simple, fast assembly of the mounting plate. Slide rails may be removed and installed in the side frame section

框架安装  
Frame mounting

安装工具

M5梅花批头、手电钻

将四根纵梁如图方向插入前后框架，使用梅花槽沉头三角锁紧螺钉M5×20对孔固定。

Installation tool

1. M5 Torx screwdriver bit and hand drill

2. Insert the four longitudinal beams into the front and rear frames in the orientation shown in the diagram, and secure them through the aligned holes using M5×20 countersunk Torx triangular locking screws.

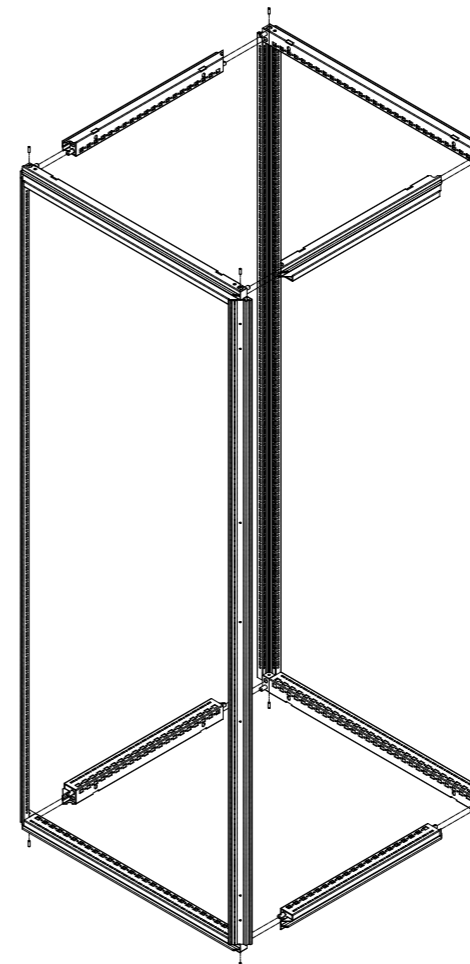

项次 Item number	描述 Description	数量 Quantity
1	梅花槽沉头三角锁紧螺钉M5×20	8个
1	M5×20 Multi-tooth Head taping screw	8 pcs

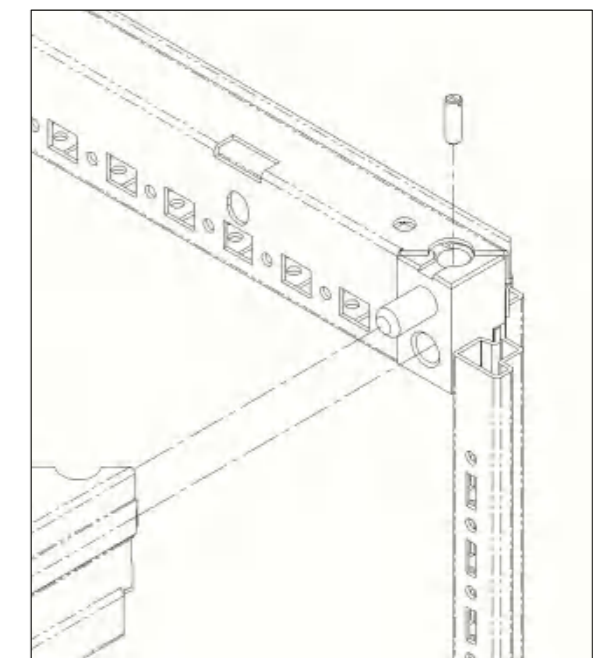



KT系列常规订货规格表

LIST OF CONVENTIONAL SPECIFICATIONS OF KT ENCLOSURES

序号 No.	类别 Category	订货号 Order No.	宽 Width (mm)	高 Height (mm)	深 Depth (mm)	供货范围 Supply Includes
1	整柜散装 Complete Enclosure (Flat Packing)	KT601650005	600	1600	500	包括: 前后框2个, 框架深度梁4根, 单开门1扇, 后板1块, 顶板1块, 运输吊环4个, 三段式底板1套, 安装板1块。  Includes: 2 front/rear frames, 4 depth beams, 1 single door, 1 rear wall, 1 roof, 4 eye-bolt, 1 bottom, 1 mounting plate. RAL 7035
2		KT601850005	600	1800	500	
3		KT601860005	600	1800	600	
4		KT602040005	600	2000	400	
5		KT602050005	600	2000	500	
6		KT602060005	600	2000	600	
7		KT602080005	600	2000	800	
8		KT802260005	600	2200	600	
9		KT801450005	800	1400	500	
10		KT801650005	800	1600	500	
11		KT801850005	800	1800	500	
12		KT801860005	800	1800	600	
13		KT801880005	800	1800	800	
14		KT802050005	800	2000	500	
15		KT802060005	800	2000	600	
16		KT802080005	800	2000	800	
17		KT802260005	800	2200	600	
18		KT102050015	1000	2000	500	
19		KT102060015	1000	2000	600	
20		KT121450015	1200	1400	500	
21		KT121840015	1200	1800	400	
22		KT121850015	1200	1800	500	
23		KT121860015	1200	1800	600	
24		KT122040015	1200	2000	400	
25		KT122050015	1200	2000	500	
26		KT122060015	1200	2000	600	
27		KT122080015	1200	2000	800	
28	KT122260015	1200	2200	600		
29	整柜整装 Complete Enclosure (Full Assembled)	KT601650105	600	1600	500	包括: 箱体框架1套, 单开门1扇, 后板1块, 顶板1块, 运输吊环4个, 三段式底板1套, 安装板1块。  Includes: 1 Enclosure frame, 1 single door, 1 rear wall, 1 roof, 4 eye-bolt, 1 bottom, 1 mounting plate. RAL 7035
30		KT601850105	600	1800	500	
31		KT601860105	600	1800	600	
32		KT602040105	600	2000	400	
33		KT602050105	600	2000	500	
34		KT602060105	600	2000	600	
35		KT602080105	600	2000	800	
36		KT602260105	600	2200	600	
37		KT801450105	800	1400	500	
38		KT801650105	800	1600	500	
39		KT801850105	800	1800	500	
40		KT801860105	800	1800	600	
41		KT801880105	800	1800	800	
42		KT802050105	800	2000	500	
43		KT802060105	800	2000	600	
44		KT802080105	800	2000	800	
45		KT802260105	800	2200	600	
46		KT102050115	1000	2000	500	
47		KT102060115	1000	2000	600	
48		KT121450115	1200	1400	500	
49		KT121840115	1200	1800	400	
50		KT121850115	1200	1800	500	
51		KT121860115	1200	1800	600	
52		KT122040115	1200	2000	400	
53		KT122050115	1200	2000	500	
54		KT122060115	1200	2000	600	
55		KT122080115	1200	2000	800	
56	KT122260115	1200	2200	600		
57	侧板 Side Wall	KTSW1650005	SW	1400	500	包括: 侧板2块, 安装附件A 1套 (侧板固定件12个, ST6.3*18 螺钉12颗)  Includes: 2 side walls, 1 set of A-type fixture accessories ( 12 fixtures, 12 ST6.3x18 Phillip- head Screws).
58		KTSW1650005	SW	1600	500	
59		KTSW1840005	SW	1800	400	
60		KTSW1850005	SW	1800	500	
61		KTSW1860005	SW	1800	600	
62		KTSW1880005	SW	1800	800	
63		KTSW2040005	SW	2000	400	
64		KTSW2050005	SW	2000	500	
65		KTSW2060005	SW	2000	600	
66		KTSW2080005	SW	2000	800	
67	KTSW2260005	SW	2200	600		



KT系列常规订货规格表

LIST OF CONVENTIONAL SPECIFICATIONS OF KT ENCLOSURES

序号 No.	类别 Category	订货号 Order No.	宽 Width (mm)	高 Height (mm)	深 Depth (mm)	供货范围 Supply Includes
1	安装板 Mounting_Plate	KT6016MP005	600	1600	MP	包括: 安装板1块, 安装附件E 1套, 镀锌板  Includes: 1 mounting plate, 1 set E-type of fixture accessories, Zinc plated
2		KT6018MP005	600	1800	MP	
3		KT6020MP005	600	2000	MP	
4		KT6022MP005	600	2200	MP	
5		KT8014MP005	800	1400	MP	
6		KT8016MP005	800	1600	MP	
7		KT8018MP005	800	1800	MP	
8		KT8020MP005	800	2000	MP	
9		KT8022MP005	800	2200	MP	
10		KT1018MP005	1000	1800	MP	
11		KT1020MP005	1000	2000	MP	
12		KT1214MP005	1200	1400	MP	
13		KT1218MP005	1200	1800	MP	
14		KT1220MP005	1200	2000	MP	
15		KT1222MP005	1200	2200	MP	
16	门 Door	KT6016DS005	600	1600	DS	包括: 小型平面锁1把, 铰链3个, 锁杆1对, 锁挡块2个, 锁舌1片。  Includes: 1 small falt lock, 3 hing, 1 pair of lock rod, 2 lock hock, 1 lock plate.
17		KT6018DS005	600	1800	DS	
18		KT6020DS005	600	2000	DS	
19		KT6022DS005	600	2200	DS	
20		KT8014DS005	800	1400	DS	
21		KT8016DS005	800	1600	DS	
22		KT8018DS005	800	1800	DS	
23		KT8020DS005	800	2000	DS	
24		KT8022DS005	800	2200	DS	
25		KT1018DD005	1000	1800	DD	
26		KT1020DD005	1000	2000	DD	
27		KT1214DD005	1200	1400	DD	
28		KT1218DD005	1200	1800	DD	
29		KT1220DD005	1200	2000	DD	
30		KT1222DD005	1200	2200	DD	
31	后板 Rear Wall	KT6016RW005	600	1600	RW	包括: 后板1块, 安装附件C 1套(背板固定件6个 M6*10内六角螺丝6颗, M6*16螺丝6颗)。  Includes: 1 rear wall, 1 set of C-type fixture accessories ( 6 Real Plate Fixtures, 6 M6x10 AllenHead Screws, 6 M6x16 Phillip-headScrews).
32		KT6018RW005	600	1800	RW	
33		KT6020RW005	600	2000	RW	
34		KT6022RW005	600	2200	RW	
35		KT8014RW005	800	1400	RW	
36		KT8016RW005	800	1600	RW	
37		KT8018RW005	800	1800	RW	
38		KT8020RW005	800	2000	RW	
39		KT8022RW005	800	2200	RW	
40		KT1018RW005	1000	1800	RW	
41		KT1020RW005	1000	2000	RW	
42		KT1214RW005	1200	1400	RW	
43		KT1218RW005	1200	1800	RW	
44		KT1220RW005	1200	2000	RW	
45		KT1222RW005	1200	2200	RW	
46	前后框 Front/Rear Frame	KT6016FF005	600	1600	FF	包括: 前后框架2个 Includes: 2 frames
47		KT6018FF005	600	1800	FF	
48		KT6020FF005	600	2000	FF	
49		KT6022FF005	600	2200	FF	
50		KT8014FF005	800	1400	FF	
51		KT8016FF005	800	1600	FF	
52		KT8018FF005	800	1800	FF	
53		KT8020FF005	800	2000	FF	
54		KT8022FF005	800	2200	FF	
55		KT1018FF005	1000	1800	FF	
56		KT1020FF005	1000	2000	FF	
57		KT1214FF005	1200	1400	FF	
58		KT1218FF005	1200	1800	FF	
59		KT1220FF005	1200	2000	FF	
60		KT1222FF005	1200	2200	FF	
61	框架深度梁 Depth Beam	KTFDFD40005	FD	FD	400	包括: 框架深度梁4根, M5*20螺丝8颗。 Includes: 4 beams and 8 pieces of M5X20 screw.
62		KTFDFD50005	FD	FD	500	
63		KTFDFD60005	FD	FD	600	
64		KTFDFD80005	FD	FD	800	

KT系列尺寸规格表  
KT series dimension table

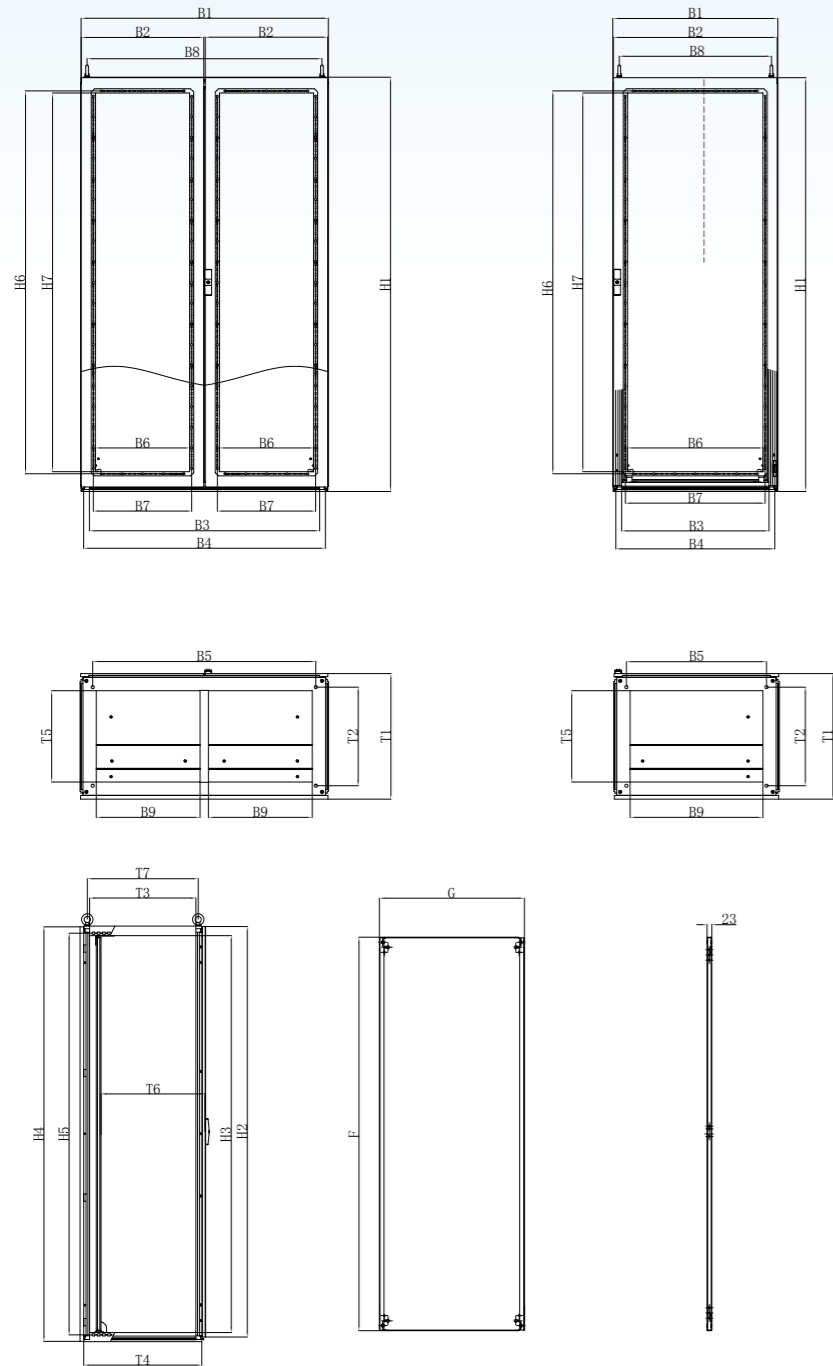

宽度 (B系列)  
 B1 总宽不含侧板  
 B2 门宽  
 B3 框架宽度开档宽度  
 B4 底框宽度  
 B5 底框固定孔宽度  
 B6 门加强筋宽度开档尺寸  
 B7 门加强筋中心距  
 B8 M12固定孔宽度尺寸  
 B9 底框开孔宽度尺寸

高度 (H系列)  
 H1 总高不含吊环  
 H2 门高  
 H3 框架高度度开档宽度  
 H4 后板高度  
 H5 上下水平型材固定孔中心距  
 H6 门加强筋中心距  
 H7 门加强筋高度开档尺寸

深度 (T系列)  
 T1 总深不含锁面高度  
 T2 底框固定孔深度  
 T3 框架深度度开档宽度  
 T4 底框深度  
 T5 底框开孔深度度尺寸  
 T6 安装板深度到门内表面  
 T7 M12固定孔深度度尺寸

其它尺寸  
 F 安装板总高  
 G 安装板总宽

Width (B Series):  
 B1 Overall width (excluding side panels)  
 B2 Door width  
 B3 Frame width / Opening width  
 B4 Base frame width  
 B5 Base frame fixing hole width  
 B6 Door reinforcement rib opening width  
 B7 Door reinforcement rib center distance  
 B8 M12 fixing hole width  
 B9 Base frame opening width

Height (H Series):  
 H1 Overall height (excluding lifting lugs)  
 H2 Door height  
 H3 Frame height / Opening width  
 H4 Rear panel height  
 H5 Upper & lower horizontal profile fixing hole center distance  
 H6 Door reinforcement rib center distance  
 H7 Door reinforcement rib opening height

Depth (T Series):  
 T1 Overall depth (excluding lock face height)  
 T2 Base frame fixing hole depth  
 T3 Frame depth / Opening width  
 T4 Base frame depth  
 T5 Base frame opening depth  
 T6 Mounting plate depth (to inner door surface)  
 T7 M12 fixing hole depth

Other Dimensions:  
 F Mounting plate total height  
 G Mounting plate total width

规格尺寸 Dimension			宽度 Width								高度 Height					深度 Depth						安装板 Mounting Plate					
宽 Width	高 Height	深 Depth	B1	B2	B3	B4	B5	B6	B7	B8	B9	H1	H2	H3	H4	H5	H6	H7	T1	T2	T3	T4	T5	T6	T7	F	G
600	1800	400	597	592	512	568	475	455	475	535	440	1800	1777.5	1712	1797	1735	1750	1630	405	275	312	368	240	126.5-356.5	335	1696	499
600	1800	500	597	592	512	568	475	455	475	535	440	1800	1777.5	1712	1797	1735	1750	1630	505	375	412	468	340	126.5-456.5	435	1696	499
600	1800	600	597	592	512	568	475	455	475	535	440	1800	1777.5	1712	1797	1735	1750	1630	605	475	512	568	440	126.5-556.5	535	1696	499
600	2000	400	597	592	512	568	475	455	475	535	440	2000	1977.5	1912	1997	1935	1850	1830	405	275	312	368	240	126.5-356.5	335	1896	499
600	2000	500	597	592	512	568	475	455	475	535	440	2000	1977.5	1912	1997	1935	1850	1830	505	375	412	468	340	126.5-456.5	435	1896	499
600	2000	600	597	592	512	568	475	455	475	535	440	2000	1977.5	1912	1997	1935	1850	1830	605	475	512	568	440	126.5-556.5	535	1896	499
600	2000	800	597	592	512	568	475	455	475	535	440	2000	1977.5	1912	1997	1935	1850	1830	805	675	712	768	640	126.5-756.6	735	1896	499
600	2200	600	597	592	512	568	475	455	475	535	440	2200	2177.5	2112	2197	2135	2050	2030	605	475	512	568	440	126.5-556.5	535	2096	499
800	1800	400	797	792	712	768	675	655	675	735	640	1800	1777.5	1712	1797	1735	1750	1630	405	275	312	368	240	126.5-356.5	335	1696	699
800	1800	500	797	792	712	768	675	655	675	735	640	1800	1777.5	1712	1797	1735	1750	1630	505	375	412	468	340	126.5-456.5	435	1696	699
800	1800	600	797	792	712	768	675	655	675	735	640	1800	1777.5	1712	1797	1735	1750	1630	605	475	512	568	440	126.5-556.5	535	1696	699
800	2000	400	797	792	712	768	675	655	675	735	640	2000	1977.5	1912	1997	1935	1850	1830	405	275	312	368	240	126.5-356.5	335	1896	699
800	2000	500	797	792	712	768	675	655	675	735	640	2000	1977.5	1912	1997	1935	1850	1830	505	375	412	468	340	126.5-456.5	435	1896	699
800	2000	600	797	792	712	768	675	655	675	735	640	2000	1977.5	1912	1997	1935	1850	1830	605	475	512	568	440	126.5-556.5	535	1896	699
800	2000	800	797	792	712	768	675	655	675	735	640	2000	1977.5	1912	1997	1935	1850	1830	805	675	712	768	640	126.5-756.6	735	1896	699
800	2200	600	797	792	712	768	675	655	675	735	640	2200	2177.5	2112	2197	2135	2050	2030	605	475	512	568	440	126.5-556.5	535	2096	699
1000	1800	400	997	492	912	968	875	355	375	935	400	1800	1777.5	1712	1797	1735	1750	1630	405	275	312	368	240	126.5-356.5	335	1896	899
1000	2000	500	997	492	912	968	875	355	375	935	400	2000	1977.5	1912	1997	1935	1850	1830	505	375	412	468	340	126.5-456.5	435	2096	899
1000	2000	600	997	492	912	968	875	355	375	935	400	2000	1977.5	1912	1997	1935	1850	1830	605	475	512	568	440	126.5-556.5	535	2096	899
1200	1800	400	1197	592	1112	1168	1075	455	475	1135	500	1800	1777.5	1712	1797	1735	1750	1630	405	275	312	368	240	126.5-356.5	335	1696	1099
1200	1800	500	1197	592	1112	1168	1075	455	475	1135	500	1800	1777.5	1712	1797	1735	1750	1630	505	375	412	468	340	126.5-456.5	435	1696	1099
1200	1800	600	1197	592	1112	1168	1075	455	475	1135	500	1800	1777.5	1712	1797	1735	1750	1630	605	475	512	568	440	126.5-556.5	535	1696	1099
1200	2000	400	1197	592	1112	1168	1075	455	475	1135	500	2000	1977.5	1912	1997	1935	1850	1830	405	275	312	368	240	126.5-356.5	335	1896	1099
1200	2000	500	1197	592	1112	1168	1075	455	475	1135	500	2000	1977.5	1912	1997	1935	1850	1830	505	375	412	468	340	126.5-456.5	435	1896	1099
1200	2000	600	1197	592	1112	1168	1075	455	475	1135	500	2000	1977.5	1912	1997	1935	1850	1830	605	475	512	568	440	126.5-556.5	535	1896	1099
1200	2000	800	1197	592	1112	1168	1075	455	475	1135	500	2000	1977.5	1912	1997	1935	1850	1830	805	675	712	768	640	126.5-756.6	735	1896	1099
1200	2200	600	1197	592	1112	1168	1075	455	475	1135	500	2200	2177.5	2112	2197	2135	2050	2030	605	475	512	568	440	126.5-556.5	535	2096	1099



产品特点 Features of Products

- 预装有角连接件的前后底座部件对某一所选定宽度始终是相同的。
- 根据相应的机柜深度和所希望的底座配置选取侧面护板。通过模块化方案能够在投资成本和功能方面具有特别的优势。
- 机柜上的安装可十分便捷舒适地从外部进行。底座内部空间为电缆管理的安装平面提供了多种多样的可能性。

- The base/plinth components at the front and rear, pre-configured with corner pieces, are always the same for the chosen width.
- Only the side trim panels are selected according to the enclosure depth and the required base/plinth configuration. The modular concept produces exceptional advantages in terms of cost and function.
- Mounting on the enclosure is conveniently carried out from the outside. Diverse mounting levels inside the base/plinth offers many opportunities for cable management.

底座 高度 Base/plinth height	基本形状 Basic form	电缆导引的方案 Cable entry options				
100 mm					并柜底座的加固 Stabilisation of bayed base/plinths	
200 mm						

订货规格表  
Order specifications table

序号 No.	类别 Category	KP订货号 Order No.	KT订货号 Order No.	宽 Width (mm)	高 Height (mm)	深 Depth (mm)	描述 Description
1	底座前后 Base / Plinth For Front and Rear	KP6010BF00J	KT6010BF00J	600	100	BF	包括：4个底座部件，4个封闭罩，4颗螺钉和用于在机柜上安装的插入式螺母，RAL9005  Includes: 4base/plinth components, 4 cover caps, 4 screws and cage nuts M12 for mounting on the enclosure, RAL9005
2		KP8010BF00J	KT8010BF00J	800	100	BF	
3		KP1010BF00J	KT1010BF00J	1000	100	BF	
4		KP1210BF00J	KT1210BF00J	1200	100	BF	
5		KP6020BF00J	KT6020BF00J	600	200	BF	
6		KP8020BF00J	KT8020BF00J	800	200	BF	
7		KP1020BF00J	KT1020BF00J	1000	200	BF	
8		KP1220BF00J	KT1220BF00J	1200	200	BF	
9	底座侧板 Base / Plinth trim for side	KPBL104000J	KTBL104000J	BL	100	400	包括：侧面护板2块，安装附件1套。RAL9005  Includes: 2 left/right plates, 1 set of fixture accessories. RAL9005
10		KPBL105000J	KTBL105000J	BL	100	500	
11		KPBL106000J	KTBL106000J	BL	100	600	
12		KPBL108000J	KTBL108000J	BL	100	800	
13		KPBL204000J	KTBL204000J	BL	200	400	
14		KPBL205000J	KTBL205000J	BL	200	500	
15		KPBL206000J	KTBL206000J	BL	200	600	
16		KPBL208000J	KTBL208000J	BL	200	800	

# 配件 Accessory



KP33000100Z  
外并柜六角钢  
Baying kit



KP33000200Z  
角并柜件  
Angular baying brackets



KP33000300Z  
并柜吊环  
Combination angle



KT33000400Z  
并柜连接件  
Baying connectors



KP33000500Z  
内并柜件  
Baying brackets



KT33000600Z  
U形并柜件  
U shape baying brackets



KP33000700J  
19英寸盲板, 1U  
1 U Blank panel, 19"



KP33000800Z  
门限位  
Door stay



KP33000900Y  
塑料图纸盒  
Plastic wiring plan pocket

## KP并联柜并柜配件包 KPBG-0001

6\*外并柜六角  
2\*并柜吊环  
4\*角并柜件  
4\*内并柜件  
6米密封条  
配套螺丝螺母

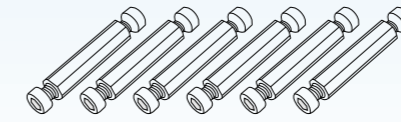

6\*外并柜六角钢 Baying kit

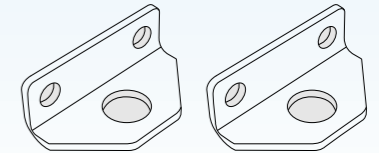

2\*并柜吊环 Combination angle

6\*Baying kit  
2\*Combination angle  
4\*Angular baying  
brackets  
4\*Baying brackets  
10 meters sealing strip  
Screws and nuts

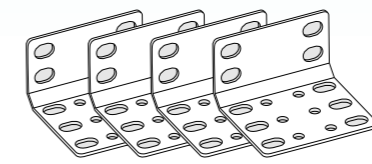

4\*角并柜件 Angular baying brackets

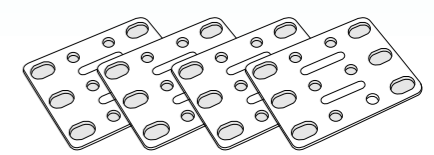

4\*内并柜件 Baying brackets

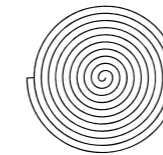

10米密封条 10 meters sealing strip

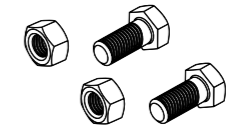

配套螺丝螺母 Screws and nuts

每两台并柜需要一套配件包 Each pair of parallel cabinets requires one set of accessories.

## KT并联柜并柜配件包 KTBG-0001

4\*角并柜件  
2\*并柜吊环  
4\*并柜连接件  
4\*内并柜件  
6米密封条  
配套螺丝螺母

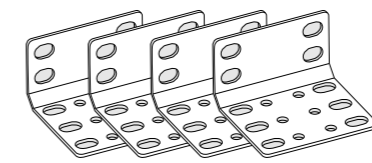

4\*角并柜件 Angular baying brackets

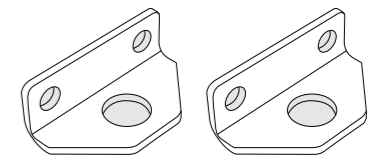

2\*并柜吊环 Combination angle

4\*Angular baying  
brackets  
2\*Combination angle  
4\*Baying connectors  
4\*Baying brackets  
6 meters sealing strip  
Screws and nuts

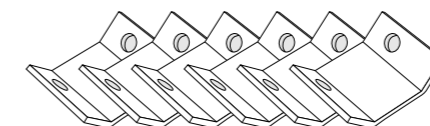

6\*并柜连接件 Baying connectors

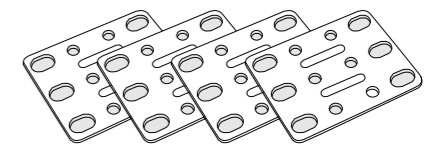

4\*内并柜件 Baying brackets

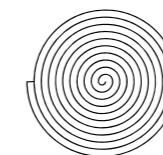

6米密封条 6 meters sealing strip

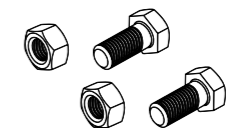

配套螺丝螺母 Screws and nuts

每两台并柜需要一套配件包 Each pair of parallel cabinets requires one set of accessories.

# 型号 MODEL NO

# SP-601

**类型 Type**

连接方式 Connection type

**标准尺寸 Standard Size**

符合行业标准 Meet industry standards

**Standard(Comply with)****(符合) 标准**ANSI/EIA,RS-310-D,DIN41497;PART  
1,DIN41494; PART7,IEC297-2,GB/  
T3047.2-92standard**材料 Material:**SPCC high quality cold-rolled steel  
SPCC优质冷轧钢**应用 Application:**Installing server interchanger etc.  
安装服务器交换机等**产品特点 PRODUCT FEATURE**

- 120毫米风扇, 可选;
- 可拆卸侧面板, 侧锁, 可选;
- 安装方便;
- 去油污、酸洗、磷酸盐防锈、纯水清洗、静电喷涂
- 可调脚和载重脚轮, 可选;
- 焊接框架, 结构可靠;
- 前门转角超过180度;
- 顶盖和底板上有敲孔, 用于电缆进入;
- SPCC冷轧钢; 可选厚度: 1.0毫米和1.2毫米
- 120mm fan optional;
- Removable side panels, sides locks optional;
- Easy mounting installation;
- Degreasing, pickling, rust-proof phosphate, pure water cleaning, electrostatic spraying
- Adjustable feet and heavy castors are optional;
- Welded frame, reliable structure;
- Turning angle of front door is over 180 degrees;
- Knock out hole for entering cable on both of top cover and bottom panel;
- SPCC cold rolled steel;Thickness: 1.0mm,1.2mm optional

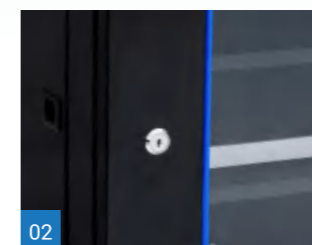

01

顶部通风孔  
Top ventilation holes

02

小圆锁, 可选  
Small round lock is optional

03

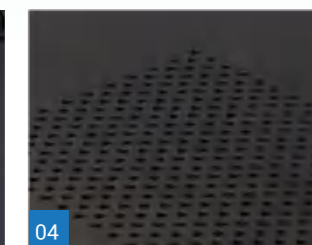
可拆卸侧面门, 使用灵活  
Removable side door, flexible use

04

顶部通风孔  
Fan ventilation holes**SP机柜说明 SP Cabinets Specification**

型号 Model	容量 (U) Capacity (U)	宽 (毫米) Width(mm)	深 (毫米) Depth(mm)	高度 (毫米) Height(mm)	组装体积(立方米) Assemble volume(CBM)
SP-601-6404	4	600	450	252	0.068
SP-601-6406	6			352	0.095
SP-601-6409	9			502	0.136
SP-601-6412	12			642	0.173
SP-601-6415	15	600	600	782	0.211
SP-601-6604	4			252	0.091
SP-601-6606	6			352	0.127
SP-601-6609	9			502	0.181
SP-601-6612	12			642	0.231
SP-601-6615	15	782	0.282		

# 型号 MODEL NO

# SP-602



静荷载  
Static loading



装配便捷  
Easy assembly



无需焊接  
No need welding

### 类型 Type

按压方式 Knock down type

### 标准尺寸 Standard Size

符合行业标准 Meet industry standards

### Standard(Comply with)

#### (符合) 标准

ANSI/EIA,RS-310-D,DIN41497;PART  
1,DIN41494; PART7,IEC297-2,GB/  
T3047.2-92standard



#### 材料 Material:

SPCC high quality cold-rolled steel  
SPCC优质冷轧钢



#### 应用 Application:

Installing server interchanger etc.  
安装服务器交换机等

## 产品特点 PRODUCT FEATURE

- 120毫米风扇, 可选;
- 节省一半的运输和储存成本;
- 安装方便;
- 去油污、酸洗、磷酸盐防锈、纯水清洗、静电喷涂
- 可拆卸结构, 扁平包装, 包装体积减少达70%;
- 前门转角超过180度;
- 顶盖和底板上有敲孔, 用于电缆进入;
- SPCC冷轧钢; 可选厚度: 1.0毫米和1.2毫米
- 120mm fan optional;
- Save half cost of shipping and storage;
- Easy mounting installation;
- Degreasing, pickling, rust-proof phosphate, pure water cleaning, electrostatic spraying
- Knock down structure, flat pack, reduce package volume up to 70%;
- Turning angle of front door is over 180 degrees;
- Knock out hole for entering cable on both of top cover and bottom panel;
- SPCC cold rolled steel;Thickness: 1.0mm,1.2mm optional



01

顶部通风孔  
Top ventilation holes

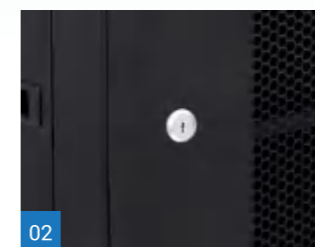

02

小圆锁, 可选  
Small round lock is optional



03

可拆卸侧面门, 使用灵活  
Removable side door, flexible use

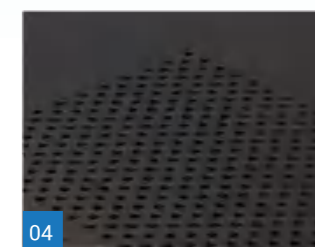

04

顶部通风孔  
Fan ventilation holes



## SP机柜说明 SP Cabinets Specification

型号 Model	容量 (U) Capacity (U)	宽 (毫米) Width(mm)	深 (毫米) Depth(mm)	高度 (毫米) Height(mm)	组装体积(立方米) Assemble volume(CBM)
SP-602-6404	4	600	450	252	0.068
SP-602-6406	6			352	0.095
SP-602-6409	9			502	0.136
SP-602-6412	12			642	0.173
SP-602-6415	15	600	600	782	0.211
SP-602-6604	4			252	0.091
SP-602-6606	6			352	0.127
SP-602-6609	9			502	0.181
SP-602-6612	12			642	0.231
SP-602-6615	15			782	0.282

# 型号 MODEL NO

# SP-603



### 类型 Type

双节式 Double section type

### 标准尺寸 Standard Size

符合行业标准 Meet industry standards

Standard(Comply with)

### (符合) 标准

ANSI/EIA,RS-310-D,DIN41497;PART  
1,DIN41494; PART7,IEC297-2,GB/  
T3047.2-92standard



### 材料 Material:

SPCC high quality cold-rolled steel  
SPCC优质冷轧钢

### 应用 Application:

Installing server interchanger etc.  
安装服务器交换机等

## 产品特点 PRODUCT FEATURE

- 标准19英寸宽度，适用标准IT产品安装；
- 深度可调节，调节范围23英寸~40英寸。适合多场景环境使用；
- 配件可拆卸，结构简单，安装方便；
- 配套可以选配标准19英寸宽度的1U托盘和2U托盘；
- 表面静电喷塑黑色工艺，美观耐用，防腐蚀防锈；
- 可落地安装使用，也可墙壁安装使用，落地承重（静载）可达500磅，壁挂承重可达200磅；
- 主要配件折弯焊接工艺，自攻丝组装，结构可靠；
- SPCC冷轧钢材质，配件1.0毫米，主竖梁厚度1.5毫米，牢固耐用
- Standard 19-inch width for IT product installation;
- Adjustable depth from 23 to 40 inches for various environments;
- Removable accessories for easy installation;
- Optional 1U and 2U trays with 19-inch width;
- Black electrostatic powder coating for durability, corrosion, and rust resistance;
- Can be floor or wall-mounted, with a floor load capacity of 500 pounds and wall load capacity of 200 pounds;
- Main accessories are made using bending and welding processes, self-tapping screw assembly, reliable structure;
- Made of SPCC cold-rolled steel, with 1.0mm thick accessories and 1.5mm thick main beams, ensuring sturdiness and durability.



## SP机柜说明 SP Cabinets Specification

型号 Model	容量 (U) Capacity (U)	宽 (毫米) Width(mm)	深 (毫米) Depth(mm)	高度 (毫米) Height(mm)	组装体积(立方米) Assemble volume(CBM)
SP-603-5509	9	582	513	491	0.147
SP-603-5512	12			625	0.187
SP-603-5515	15			758	0.226
SP-603-5520	20			982	0.293

**类型 Type**

壁挂安装型 Wall installation type

**标准尺寸 Standard Size**符合行业标准  
Meet industry standards**(符合) 标准****Standard**(Comply with)ANSI/EIA,RS-310-D,DIN41497;PART  
1,DIN41494; PART7,IEC297-2,GB/  
T3047.2-92standard**尺寸 (宽X深X高)**

Size:(W ×D×H)

600mm×450mm×368mm

**材料 Material:**SPCC high quality cold-rolled steel  
SPCC优质冷轧钢**应用 Application:**Installing server interchanger etc.  
安装服务器交换机等**型号 MODEL NO****SP-701**60KG  
静荷载  
Static loading装配便捷  
Easy assembly无需焊接  
No need welding**产品特点 PRODUCT FEATURE**

- 120毫米风扇, 可选; • 安装方便
- 节省一半的运输和储存成本;
- 前门转角超过180度;
- 可拆卸结构, 扁平包装, 包装体积减少达70%;
- 顶盖和底板上有敲孔, 用于电缆进入;
- 去油污、酸洗、磷酸盐防锈、纯水清洗、静电喷涂
- 120mm fan optional; • Easy mounting installation;
- Save half cost of shipping and storage;
- Turning angle of front door is over 180 degrees.
- Knock down structure, flat pack, reduce package volume up to 70%;
- Knock out hole for entering cable on both of top cover and bottom panel;
- Degreasing, pickling, rust-proof phosphate, pure water cleaning, electrostatic spraying

01  
钢化玻璃, 前门带冷却孔  
Tempered glass, Front door with cooling holes02  
背板上有四个挂孔  
Four hanging holes on the back panel**定制型****Custom-made model**Width  
600mmDepth  
optional  
450,600mmIP  
20

702



703



型号 MODEL NO  
**SP-801**



产品特点 PRODUCT FEATURE

- R型安装结构，无静电；
- 可拆卸侧面板，便于维护。
- 尺寸精确，工艺精巧，设计精致；
- 钢化玻璃前门，配有倾斜通风门框和三段通风后门；
- 去油污、酸洗、磷酸盐防锈、纯水清洗、静电喷涂
- 采用插接套件，机柜连接高效、可靠；
- 可同时使用可调脚和载重脚轮；
- 顶盖和底板上的电缆入口，尺寸可调；
- 可选装底座，固定机柜，使电缆进入基础底架/使基础底架通风；
- SPCC冷轧钢；厚度：安装框架使用钢板厚度：2.0毫米，安装角处使用钢板厚度：1.2毫米，其他位置使用钢板厚度：1.2毫米
- R type Mounting profiles, free of static;
- Removable side panels to ease maintain.
- Exquisite design with precise dimension and craftsmanship;
- Toughened glass front door with obliquely vented door border and three section vented rear door;
- Degreasing, pickling, rust-proof phosphate, pure water cleaning, electrostatic spraying
- Efficient and reliable cabinet connection by baying kit;
- Adjustable feet and heavy duty castors are available simultaneously;
- Cable entry on the top cover and bottom panel with adjustable sizes;
- Optional installation of plinth to enable cabinet fixation, under-base cable entry/ventilation;
- SPCC cold rolled steel; Thickness: mounting profile 2.0mm, mounting angle 1.2mm, others 1.2mm

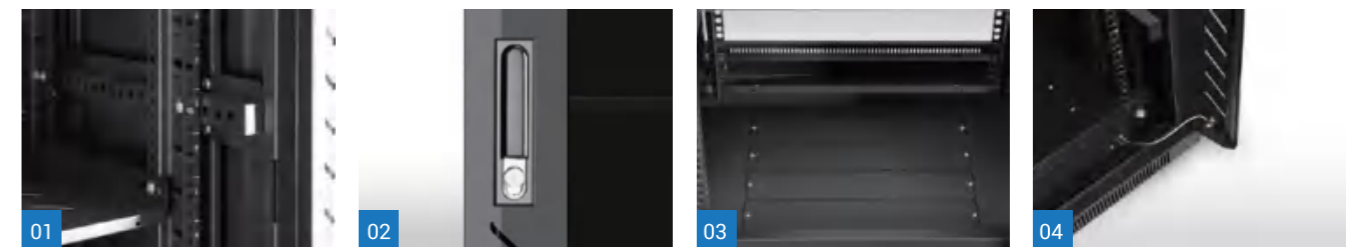

01 可调安装导轨，2.0毫米厚的安装型材更稳固  
Adjustable mounting rail, 2.0mm thickness mounting profile is stronger

02 优质门锁，开关方便  
High-quality door lock, easy to open and close

03 底部的电缆入口面积较大  
Large area of cable entry at the bottom

04 标准地线  
Standard ground wire



产品型号 Model No	前门款式 FRONT DOOR TYPE
SP-801 ■■■■■ .1 ■■	钢化前门 Toughened front door
SP-801 ■■■■■ .2 ■■	六角平网门 Hexagon flat mesh door
SP-801 ■■■■■ .3 ■■	六角弧丝网门 Hexagonal arc mesh door
SP-801 ■■■■■ .4 ■■	六角波纹网门 Hexagonal wave mesh door
SP-801 ■■■■■ .5 ■■	双开网门 Double open mesh door
SP-801 ■■■■■ .6 ■■	金属门 Metal door

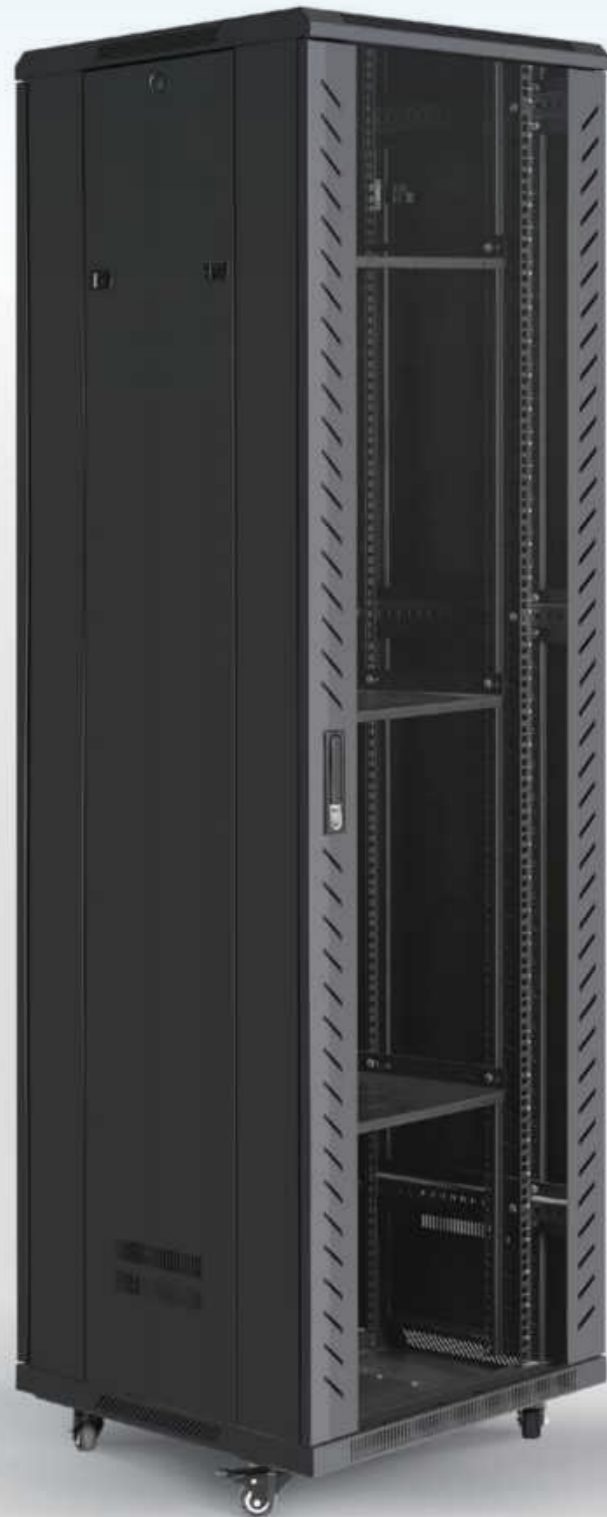

**类型 Type**  
网络机柜 Network cabinet

**标准尺寸 Standard Size**  
符合行业标准 Meet industry standards

**(符合) 标准 Standard**(Comply with)  
ANSI/EIA,RS-310-D,IEC297-2,  
DIN41494;PART1,DIN41494;  
PART7,ETSI,standard

**尺寸 (宽X深X高) Size:**(W xDxH)  
600mm×600mm×2055mm

**材料 Material:**  
SPCC high quality cold-rolled steel  
SPCC优质冷轧钢

**应用 Application**  
Installing server interchanger etc.  
安装服务器交换机等

型号 MODEL NO

**SP-801**

落地式系列  
Floor Standing Series

主要尺寸  
Main dimension

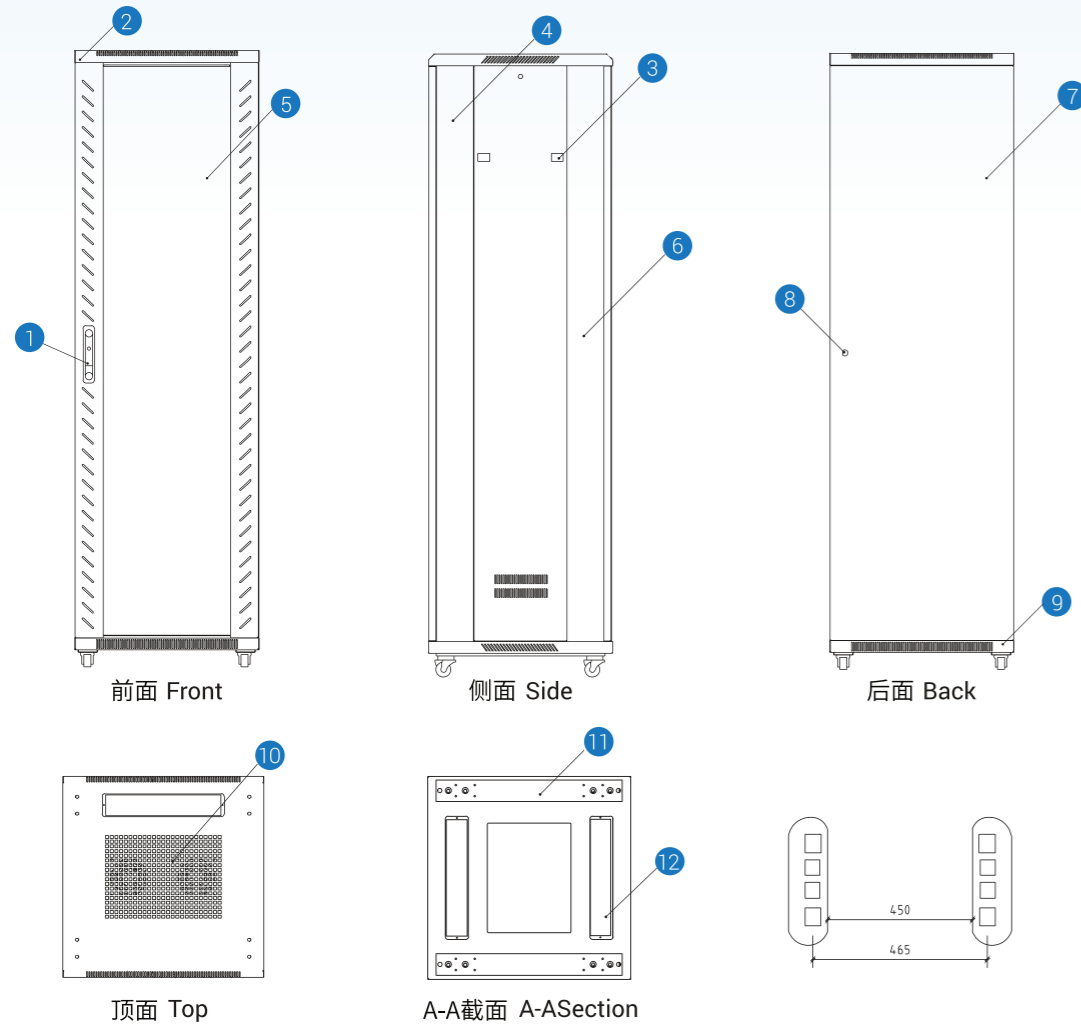

**主要部件 Main Parts**

- |  |                     |                        |                           |
|--|---------------------|------------------------|---------------------------|
| 1 高级月牙锁<br>Advanced moon-shaped lock   | 2 顶盖<br>Top cover   | 3 塑料锁<br>Plastic lock  | 4 框架<br>Frame             |
| 5 钢化玻璃前门<br>Toughened glass front door | 6 侧板<br>Side panel  | 7 后门<br>Rear door      | 8 小圆锁<br>Small round lock |
| 9 载重脚轮<br>Heavy duty castor            | 10 风扇单元<br>Fan unit | 11 脚轮板<br>Castor panel | 12 电缆入口<br>Cable entrance |

**SP-801机柜说明 SP-801 Cabinets Specification**

型号 Model	容量(U) Capacity (U)	柜体宽度(毫米) Width(mm)	柜体高度(毫米) Height (mm)	柜体深度(毫米) Depth (mm)
SP-801-6618	18	600	988	600
SP-801-6818				800
SP-801-6018		800		1000
SP-801-8818				800
SP-801-8818	22	600	1166	1000
SP-801-6622				600
SP-801-6822		800		800
SP-801-6022				1000
SP-801-8822	27	600	1388	800
SP-801-8032				800
SP-801-6627		800		600
SP-801-6827				800
SP-801-6027	32	600	1610	1000
SP-801-8827				800
SP-801-8037		800		1000
SP-801-6632				600
SP-801-6832	37	600	1833	800
SP-801-6032				800
SP-801-8832		800		1000
SP-801-8032				600
SP-801-6637	42	600	2055	800
SP-801-6837				800
SP-801-6037		800		1000
SP-801-8837				600
SP-801-8037	47	600	2277	800
SP-801-6642				600
SP-801-6842		800		1000
SP-801-6042				800
SP-801-8842	800	600	2277	600
SP-801-8042				800
SP-801-6647		800		1000
SP-801-6847				800
SP-801-6047	800	1000		
SP-801-8847		800		
SP-801-8047	1000			



**类型 Type**

服务器组柜 Server cabinet

**标准尺寸 Standard Size**

符合行业标准 Meet industry standards

**(符合) 标准**

**Standard**(Comply with)  
ANSI/EIA,RS-310-D,IEC297-2,  
DIN41494;PART1,DIN41494;  
PART7,ETSI,standard



**尺寸 (宽X深X高)**  
Size:(W xDxH)  
800mmx600mmx2055mm



**材料 Material:**  
SPCC high quality cold-rolled steel  
SPCC优质冷轧钢



**应用 Application:**  
Installing server interchanger etc.  
安装服务器交换机等

型号 MODEL NO  
**SP-802**



静荷载  
Static loading



装配便捷  
Easy assembly



无需焊接  
No need welding

**产品特点 PRODUCT FEATURE**

- R型安装结构, 无静电;
- 可拆卸侧面板, 便于维护。
- 高通风单一网格前门和双网格后门;
- 尺寸精确, 工艺精巧, 设计精致;
- 去油污、酸洗、磷酸盐防锈、纯水清洗、静电喷涂
- 添加方盒, 达到19英寸;
- 采用插接套件, 机柜连接高效、可靠;
- 可同时使用可调脚和载重脚轮;
- 顶盖和底板上的电缆入口, 尺寸可调;
- 可选装底座, 固定机柜, 使电缆进入基础底座/使基础底座通风;
- SPCC冷轧钢; 厚度: 19英寸安装角轨使用钢板厚度 2.0 毫米, 其他位置使用钢板厚度: 1.2毫米
- R type Mounting profiles, free of static;
- Removable side panels to ease maintain.
- High ventilated single mesh front door with double mesh rear door ;
- Exquisite design with precise dimension and craftsmanship;
- Degreasing, pickling, rust-proof phosphate, pure water cleaning, electrostatic spraying
- Add square box to reach 19inch;
- Efficient and reliable cabinet connection by baying kit;
- Adjustable feet and heavy duty castors are available simultaneously;
- Cable entry on the top cover and bottom panel with adjustable sizes;
- Optional installation of plinth to enable cabinet fixation, under-base cable entry/ventilation;
- SPCC cold rolled steel; Thickness: 19 inch mounting angle track 2.00mm, others 1.2mm



01  
散热  
Heat dissipation



02  
顶部风扇冷却单元  
Top fan cooling unit



03  
标准19英尺安装距离  
Standard 19 feet installation distance

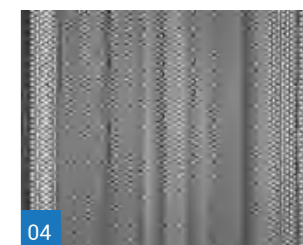

04  
弧形网门, 用于散热  
Curved mesh door for heat dissipation



Width  
350mm



Depth  
optional  
600,800,1000mm



IP  
20

产品型号 Model No	前门款式 FRONT DOOR TYPE
SP-802 ■■■■■ .1 ■■	钢化前门 Toughened front door
SP-802 ■■■■■ .2 ■■	六角平网门 Hexagon flat mesh door
SP-802 ■■■■■ .3 ■■	双开网门 Double open mesh door
SP-802 ■■■■■ .4 ■■	金属门 Metal door

型号 MODEL NO

**SP-802** 落地式系列  
Floor Standing Series

主要尺寸  
Main dimension

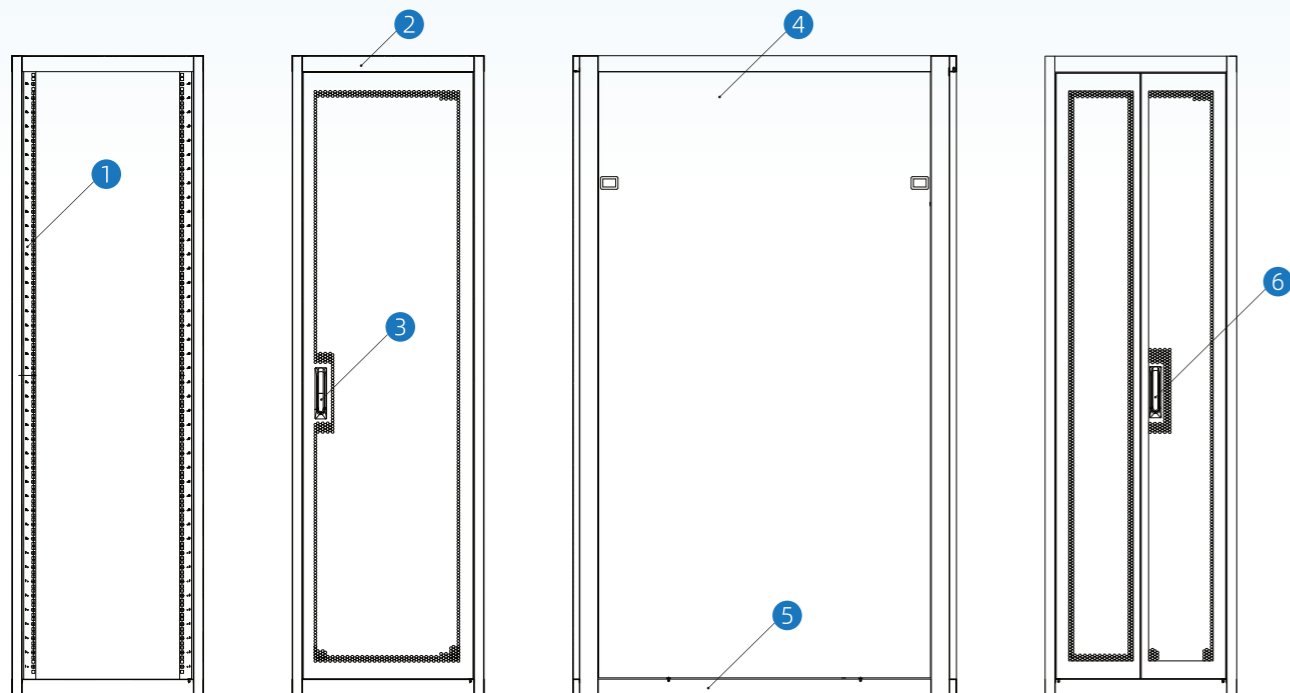

正视图 Front  
(未显示前门)  
(Without front door)

正视图 Front

侧视图 Side

后视图 Back

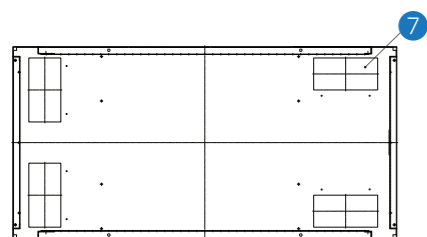

俯视图 TOP

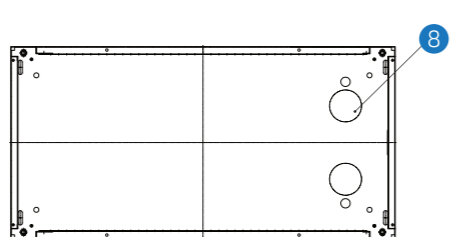

底视图 Bottom

主要部件 Main Parts

- 1** 19英寸角轨2对  
Mounting angle
- 2** 柜顶  
Top cover
- 3** 单点门锁  
Single mortise locks
- 4** 快拆侧板  
Side panel
- 5** 柜底  
Bottom panel
- 6** 三点双门锁  
Three Point Mortise Locks
- 7** 柜顶进线孔 (4处带毛刷)  
Cable entrance on bottom
- 8** 柜底进线孔 (2处敲落孔)  
Cable entrance on Top

SP-802机柜说明 SP-802 Cabinets Specification

型号 Model	容量(U) Capacity (U)	柜体宽度 (毫米) Width(mm)	柜体高度 (毫米) Height (mm)	柜体深度 (毫米) Depth (mm)	19英寸预装深度 (毫米) Installation Depth(mm)
SP-802-6618	18	600	1000	600	345
SP-802-6818				800	545
SP-802-8818		800		545	
SP-802-8038		1000		745	
SP-802-6622	22	600	1100	600	345
SP-802-6822				800	545
SP-802-8822		800		545	
SP-802-8032		1000		745	
SP-802-6627	24	600	1200	600	345
SP-802-6827				800	545
SP-802-8827		800		545	
SP-802-8037		1000		745	
SP-802-6632	32	600	1600	600	345
SP-802-6832				800	545
SP-802-8832		800		545	
SP-802-8032		1000		745	
SP-802-6637	38	600	1800	600	345
SP-802-6837				800	545
SP-802-8037		1000		745	
SP-802-8837		800		545	
SP-802-6642	42	600	2000	600	345
SP-802-6842				800	545
SP-802-6042				1000	745
SP-802-6242				1200	745
SP-802-8842		800		545	
SP-802-8042		1000		745	
SP-802-8242		1200		945	
SP-802-6647		47		600	2200
SP-802-6847	800		545		
SP-802-6047	1000		745		
SP-802-6247	1200		945		
SP-802-8847	800		545		
SP-802-8047	1000		745		
SP-802-8247	1200		945		



**类型 Type**

九折叠结构 Nine folded profiled

**标准尺寸 Standard Size**

符合行业标准  
Meet industry standards

**(符合) 标准**

**Standard**(Comply with)

ANSI/EIA,RS-310-D,IEC297-2,  
DIN41494;PART1,DIN41494;  
PART7,ETSI,standard



**尺寸 (宽X深X高)**  
**Size:**(W xDxH)  
600mmx1000mmx2055mm



**材料 Material:**  
SPCC high quality cold- rolled steel  
SPCC优质冷轧钢



**应用 Application:**  
Installing server interchanger etc.  
安装服务器交换机等

型号 MODEL NO  
**SP-803**



静荷载  
Static loading



装配便捷  
Easy assembly



无需焊接  
No need welding

**产品特点 PRODUCT FEATURE**

- R型安装结构, 无静电;
- 可拆卸侧面板, 便于维护。
- 高通风单一网格前门和双网格后门;
- 尺寸精确, 工艺精巧, 设计精致;
- 去油污、酸洗、磷酸盐防锈、纯水清洗、静电喷涂
- 采用插接套件, 机柜连接高效、可靠;
- 可同时使用可调脚和载重脚轮;
- 顶盖和底板上的电缆入口, 尺寸可调;
- 可选装底座, 固定机柜, 使电缆进入基础底架/使基础底架通风;
- SPCC冷轧钢; 使用9折框架结构, 料厚1.5毫米; 19英寸安装角轨2.0毫米; 安装角处使用钢板厚度; 其他位置使用钢板厚度: 1.2毫米
- R type Mounting profiles, free of static;
- Removable side panels to ease maintain.
- High ventilated single mesh front door with double mesh rear door ;
- Exquisite design with precise dimension and craftsmanship;
- Degreasing, pickling, rust-proof phosphate, pure water cleaning, electrostatic spraying
- Add square box to reach 19inch;
- Efficient and reliable cabinet connection by baying kit;
- Adjustable feet and heavy duty castors are available simultaneously;
- Cable entry on the top cover and bottom panel with adjustable sizes;
- Optional installation of plinth to enable cabinet fixation, under-base cable entry/ventilation;
- SPCC cold rolled steel; Thickness: 19 inch mounting angle track 2.00mm, others 1.2mm

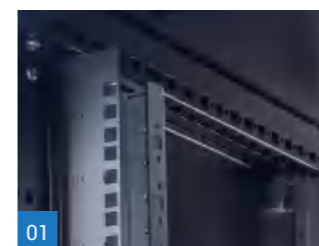

01 九折型材框架结构, 静载荷超过1500kg  
Nine-fold profile frame structure, static load capacity exceeding 1500kg.



02 顶部和底部配置进线毛刷, 做到有效的线缆保护  
Top and bottom cable entry brushes for effective cable protection.



03 机柜门采用120° 铰链和舒适把手锁, 方便维护  
Doors with 120° hinges and comfort handle for easy maintenance.

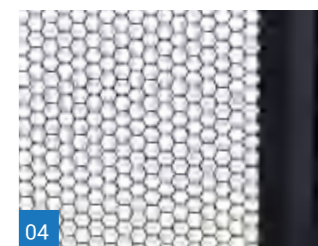

04 高密度网孔门, 通风率超过80%  
High-density mesh doors offer a ventilation rate of over 80%.



Width  
600,800mm



Depth  
600,800,1000mm



IP  
20

产品型号 Model No	前门款式 FRONT DOOR TYPE
SP-803 ■■■■■ .1 ■■	钢化前门 Toughened front door
SP-803 ■■■■■ .2 ■■	六角平网门 Hexagon flat mesh door
SP-803 ■■■■■ .3 ■■	双开网门 Double open mesh door
SP-803 ■■■■■ .4 ■■	金属门 Metal door

型号 MODEL NO

**SP-803** 落地式系列  
Floor Standing Series

主要尺寸  
Main dimension

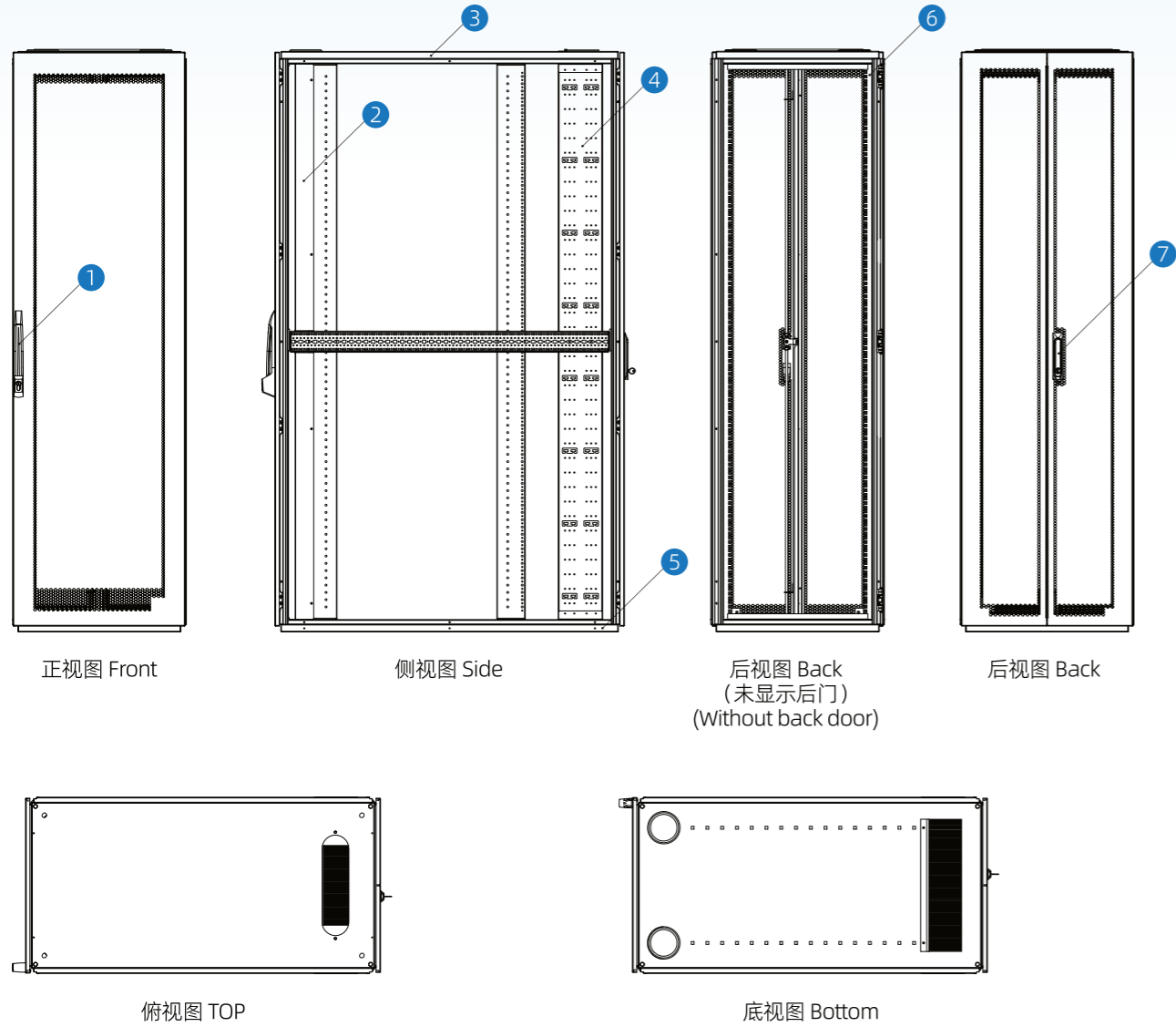

主要部件 Main Parts

- 1 前门锁 (豪华手柄3点) Three Point Mortise Locks
- 2 挡风板套件 (选配) Windshield panel kit (optional)
- 3 柜顶 Top cover
- 4 垂直理线板 (选配) Cable management panel (optional)
- 5 柜底 Bottom panel
- 6 19英寸角轨2对 Mounting angle
- 7 后门锁 (金属手柄3点) Three Point Mortise Locks for back door

SP-803机柜说明 SP-803 Cabinets Specification

型号 Model	容量(U) Capacity (U)	柜体宽度 (毫米) Width(mm)	柜体高度 (毫米) Height (mm)	柜体深度 (毫米) Depth (mm)	19英寸预装深度 (毫米) Installation Depth(mm)
SP-803-6618	18	600	1000	600	345
SP-803-6818		800		800	545
SP-803-8818		800		800	545
SP-803-8038	22	800	1100	1000	745
SP-803-6622		600		600	345
SP-803-6822		800		800	545
SP-803-8822	24	800	1200	1000	745
SP-803-8032		600		600	345
SP-803-6627		800		800	545
SP-803-6827	32	800	1600	1000	745
SP-803-8037		600		600	345
SP-803-6632		800		800	545
SP-803-6832	38	800	1800	1000	745
SP-803-8032		600		600	345
SP-803-6637		800		800	545
SP-803-6837	42	800	2000	1000	745
SP-803-6037		600		600	345
SP-803-8837		800		800	545
SP-803-8037	47	800	2200	1200	945
SP-803-6642		600		600	345
SP-803-6842		800		800	545
SP-803-6042	47	800	2200	1000	745
SP-803-6242		600		600	345
SP-803-8842		800		800	545
SP-803-8042	47	800	2200	1200	945
SP-803-8242		600		600	345
SP-803-6647		800		800	545
SP-803-6847	47	800	2200	1000	745
SP-803-6047		600		600	345
SP-803-6247		800		800	545
SP-803-8847	47	800	2200	1200	945
SP-803-8047		600		600	345
SP-803-8247		800		800	545

# 产品 Products 配件 Accessory



SP-U300-A  
通用架  
Universal shelf



SP-U300-B  
通用架  
Universal shelf



SP-U300-C  
通用架  
Universal shelf



SP-F300  
固定架  
Fixed shelf

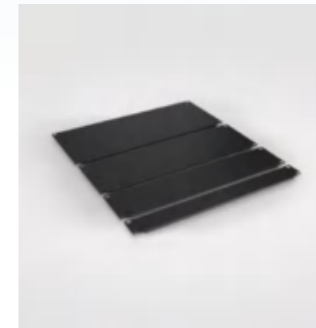

SP-B2  
2U空白面板  
2U Blanking panel



SP-B1  
空白面板  
Blank panel



SP-B3  
空白面板  
Blank panel

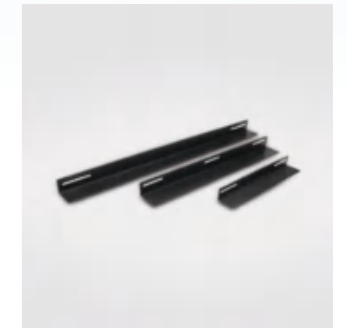

SP-L  
L型托架  
L type bracket



SP-S300  
滑架  
Sliding shelf



SP-SC  
后滑架  
Back sliding shelf

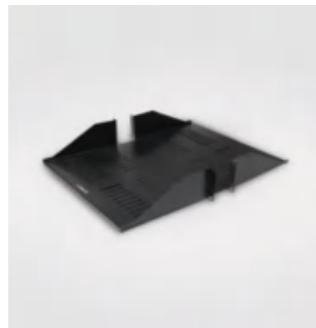

SP-CC  
中间双耳架  
Middle two-ear shelf



SP-T300  
抽屉架  
Drawer shelf



SP-T3F2-1U3002  
2风扇数字化温度单元  
2 Fans digital temperature Unit



SP-PJ-006  
风机  
FAN



SP-PJ-001  
2.5英寸脚轮, 带刹车  
2.5inch castor with breaker



SP-PJ-002  
2.5英寸脚轮, 带刹车  
2.5inch castor with breaker



SP-M4  
5孔电缆管理  
5 hole cable management



SP-M2  
24孔金属电缆管理  
24 hole metal cable management



SP-M1  
24孔电缆管理  
24 hole cable management



SP-M3  
12孔金属电缆管理  
12 hole metal cable management



SP-PJ-004  
M6螺丝  
M6 screw



SP-PJ-004B  
M6锁紧螺母  
M6 cage nut



SP-PJ-003  
可调脚  
Adjustable feet



SP-PJ-005  
下陷锁环  
Sunken code loop

# 定制 Custom made



SP-402



SP-403



SP-404



SP-405



SP-401



SP-406



SP-504



SP-604

# PDU



SP-P1

6出口德国PDU 16A型输入和输出, 带主开关, 1.5米长电缆, 绞盘标准安装

6-outlet Germany type PDU  
16A input and output with master switch,  
1.5m length cable,  
19inch standard installation



SP-P4

6出口美国PDU 15A型输入和输出, 带主开关, 1.5米长电缆, 19英寸, 标准安装

6-outlet America type PDU  
15A input and output with master switch,  
1.5m length cable,  
19inch standard installation



SP-P2

6出口法国PDU 16A型输入和输出, 带主开关, 1.5米长电缆, 19英寸, 标准安装

6-outlet French type PDU  
16A input and output with master switch,  
1.5m length cable,  
19inch standard installation



SP-P5

6出口意大利PDU 16A型输入和输出, 带主开关, 1.5米长电缆, 19英寸, 标准安装

6-outlet Italy type PDU  
16A input and output with master switch,  
1.5m length cable,  
19inch standard installation



SP-P3

6出口英国PDU 13A型输入和输出, 带主开关, 1.5米长电缆, 19英寸, 标准安装

6-outlet UK type PDU  
13A input and output with master switch,  
1.5m length cable,  
19inch standard installation



SP-P6

6出口全球PDU 10A型输入和输出, 带主开关, 1.5米长电缆, 19英寸, 标准安装

6-outlet Universal PDU  
10A input and output with master switch,  
1.5m length cable,  
19inch standard installation

				
MSP1000-2 005	MSP1000-5 005	MSP1000-10 005	MSP1000-2D 005	MSP1000-2A(内定位) (Internal Positioning) 005
				
MSP1000-5A(内定位) (Internal Positioning) 005	MSP1000-10A(内定位) (Internal Positioning) 005	MSP1000-2F 005	MSP1000-11 006	MSP1000-14 006
				
MSP1000-17 006	MSP1002-2(不锈钢) (stainless steel) 006	MSP1002-5(不锈钢) (stainless steel) 006	MSP1002-10(不锈钢) (stainless steel) 006	MSP1000-2AD 007
				
MSP1003-10 007	MSP1003-2 007	MSP1000-2G 008	MSP1000-2SG(S型锁芯) (S-type Cylinder) 008	MSP1000-5G 008
				
MSP1000-10G 008	MSP1000-15 009	MSP1000-16 009	MSP1000-9R 010	MSP1000-10R 010
				
MSP1004-1(塑料手柄) (Plastic Handle) 011	MSP1004-2 011	MSP1005-2 011	MSP1006-1 012	MSP1007-1 012

				
MSP1008-1 012	MSP1010-1(外定位) (Internal Positioning) 013	MSP1010-1A(内定位) (Internal Positioning) 013	MSP1011-1A(内定位) (Internal Positioning) 013	MSP1011-1B 013
				
MSP1012-1 014	MSP1012-1A 014	MSP1013-1 014	MSP1013-1A 014	MSP1014-1 015
				
MSP1014-2 015	MSP1014-3 015	MSP1014-4 015	MSP1014-2A 016	MSP1014-2A 016
				
MSP1014-5 017	MSP1014-6 017	MSP1015-1 018	MSP1016-1 018	MSP1017-1 018
				
MSP1017-2 018	MSP1015-1A 019	MSP1016-1A 019	MSP1017-1A 019	MSP1015-1C 020
				
MSP1016-1C 020	MSP1016-2C 020	MSP1017-1C 020	MSP1016-4 021	MSP1017-4 021

				
MSP1016-4C 021	MSP1017-4C 021	MSP1016-5S 022	MSP1017-2C 023	MSP1016-1B 023
				
MSP1017-1B 023	MSP1016-2B 023	MSP1016-2 024	MSP1016-3 024	MSP1016-1HG 024
				
MSP1016-3D 025	MSP1016-1D 025	MSP1020-1 025	MSP1021-1 025	MSP1032-1 026
				
MSP1031-1 026	MSP1030-1 027	MSP1037-1 027	MSP1033-1 028	MSP1033-1A 028
				
MSP1035-1 028	MSP1035-1A 028	MSP1039-1 029	MSP1092-1 029	MSP1040-2 030
				
MSP1040-4 030	MSP1040-5 030	MSP1036-1 031	MSP1054-1 031	MSP1055-1 032

				
MSP1071-1 032	MSP1072-1 032	MSP1074-1 033	MSP1074-2 033	MSP1074-3 033
				
MSP1073-1 034	MSP1076-1 034	MSP1083-1(7032色) (7032 color) 035	MSP1083-1(7035色) (7035 color) 035	MSP1083-2(塑料锁壳) (Plastic Lock Housing) 035
				
MSP1083-3 035	MSP1083-4 035	MSP1085-1 036	MSP1086-1 036	MSP1086-1A 036
				
MSP1089-1(镀镍) (nickel plating) 037	MSP1089-1(镀铬) (chrome plating) 037	MSP1088-1 037	MSP1090-1 038	MSP1090-1A 038
				
MSP1091-1 039	MSP1091-1 039	MSP1091-3 039	MSP1091-4 039	MSP1093-1 040

MSP

L&T HANDLES SERIES

执手锁系列



MSP

SWING HANDLES & LEVER LATCHES SERIES

平面锁系列

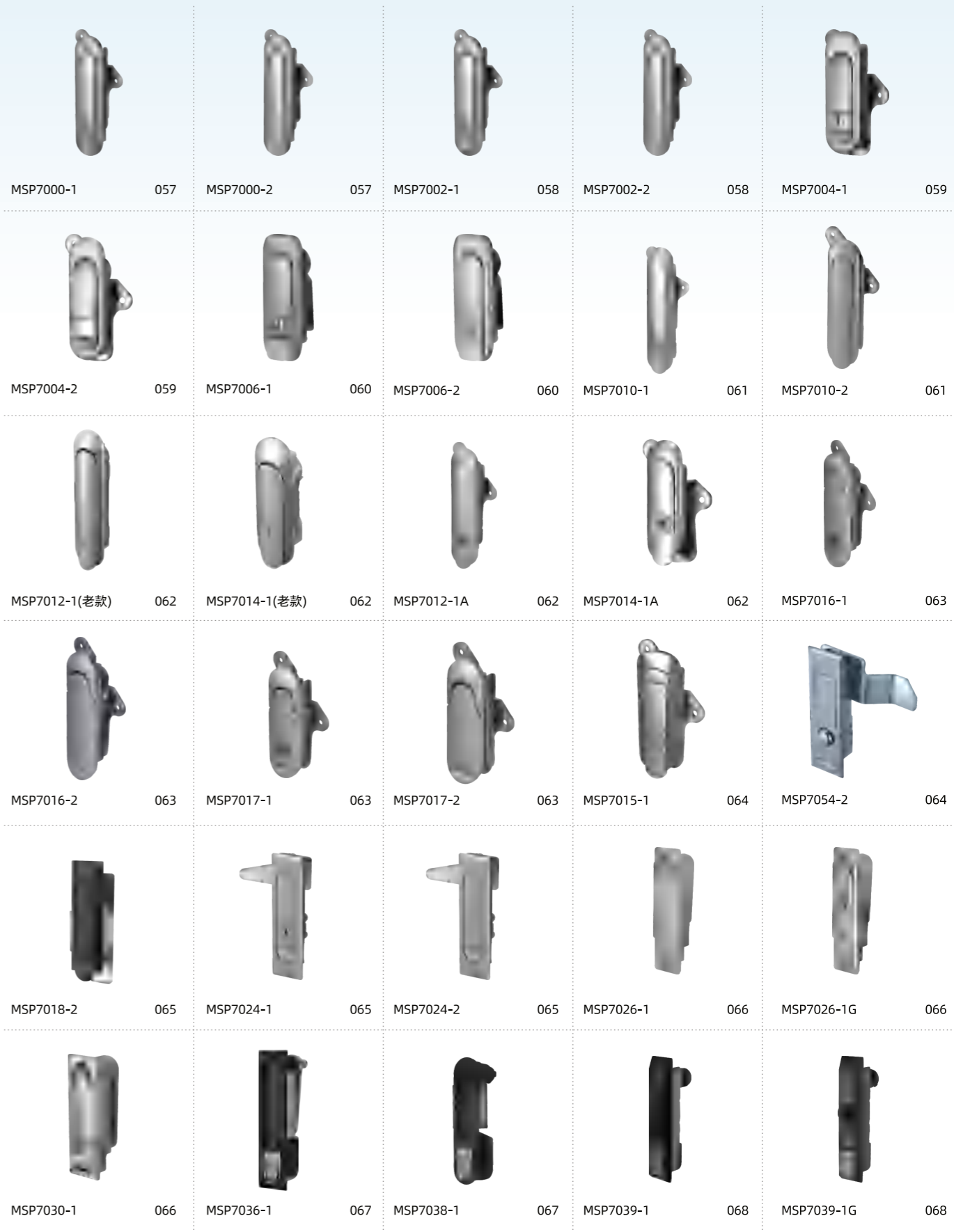

MSP

SWING HANDLES & LEVER LATCHES SERIES

平面锁系列



MSP

ROD LATCH SERIES

连杆锁系列





MSP8050-1  
095



MSP8066-2T  
096



MSP8052-1  
097



MSP8052-2  
097



MSP8052-3  
097



MSP8066-1  
098



MSP8066-2  
098



MSP8066-3  
098



MSP8066-4  
098



MSP8066-6  
098



MSP8067-1  
099



MSP8067-2  
099



MSP8067-6  
099



MSP8070-6  
100

# AISLE HOT AND COLD AISLE CONTAINMENT SYSTEM

## Aisle冷热通道系统



SAIP ELECT.

Copyright © Saip ELEC. All Right Reserved  
Deliver happiness to everyone



SP

RPP COMPACT POWER DISTRIBUTION CABINET

RPP紧密配电列头柜



**材料 Material:**  
SPCC high quality cold-rolled steel  
SPCC优质冷轧钢



**应用 Application:**  
Installing server interchanger etc.  
安装服务器交换机等

信号灯及声光告警  
Signal Light and Audible/Visual Alarm

人机界面  
Human-Machine Interface (HMI)

输入断路器  
Input Circuit Breaker

浪涌保护器  
Surge Protector

输出断路器  
Output Circuit Breaker

输出检测CT  
Output Monitoring CT

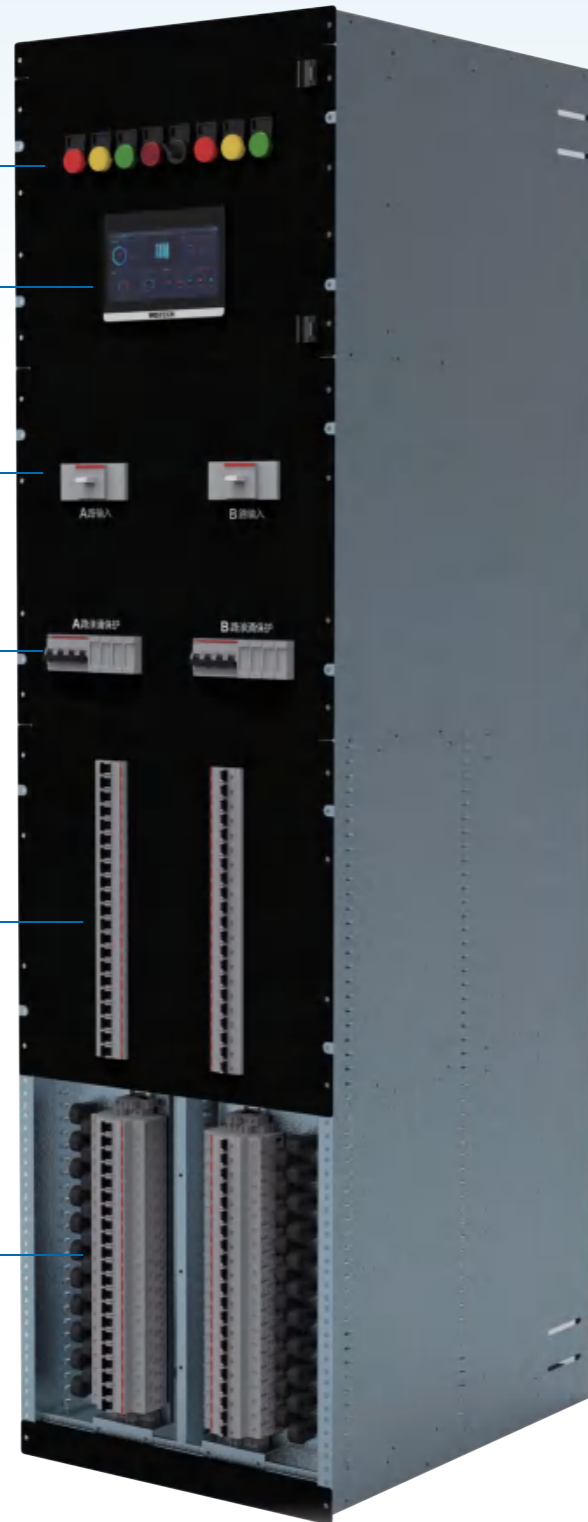

## HMI人机界面

### HMI (Human-Machine Interface)

- 采用高清电容型触摸屏，分辨率1024\*600。
- 采用工业级高品质元件，高防护等级设计。
- 全面三防喷涂，针对各种环境都可轻松应对。
- Features a high-definition capacitive touchscreen with a resolution of 1024\*600.
- Utilizes industrial-grade high-quality components with a high protection level design.
- Comprehensive three-proof coating ensures reliable performance in various environments.



## 输入断路器

### Input Circuit Breaker

- 标配采用ABB TMAX系列塑壳断路器，可选施耐德或西门子塑壳断路器
- 标配辅助触头与告警触头，可检测塑壳断路器开关状态及脱扣状态
- 特殊要求可选配分励脱扣器，用于消防切非
- Standard: ABB TMAX series; Schneider or Siemens options available.
- Includes auxiliary and alarm contacts for monitoring switch and trip status.
- Optional shunt trip for fire safety systems.



## 输入电气参数检测

### Input Electrical Parameter Monitoring

- 采用先进的DSP数字信号处理器，集成度高，运算能力强，数值运算及时准确。
- 实时监测进线回路的相电压、线电压、零地电压、相电流、电流不平衡率、电压不平衡率、有功功率、无功功率、视在功率、功率因数、系统频率、谐波、电量等电气参数。
- 同时可提供各个参数的越限告警功能及进线断路器的开关和告警状态。
- Uses advanced DSP for accurate and timely calculations.
- Monitors parameters like phase voltage, line voltage, neutral-to-ground voltage, phase current, power factors, system frequency, harmonics, and energy consumption.
- Provides over-limit alarms and monitors the status of the incoming circuit breaker.



## 输出电气参数检测

### Output Electrical Parameter Monitoring

- 监测输出回路的电压、电流、有功功率、无功功率、视在功率、功率因数、电流谐波及电量数据。
- 监测各个分支断路器的开关状态。
- 可选监测分支断路器的告警状态。
- Monitors the output circuit's voltage, current, active power, reactive power, apparent power, power factor, current harmonics, and energy consumption data.
- Monitors the switch status of each branch circuit breaker.
- Optional monitoring of the alarm status for branch circuit breakers.



## 输出断路器

### Output Circuit Breaker

- 标配采用ABB S200系列微型断路器，可选施耐德或西门子微型断路器
- 可根据要求选配热插拔底座和热插拔断路器
- 可选配底部安装辅助触头检测开关状态
- Standard configuration uses ABB S200 series miniature circuit breakers, with options for Schneider or Siemens miniature circuit breakers.
- Hot-swappable bases and circuit breakers are available as options.
- Optional bottom-mounted auxiliary contacts for switch status detection.



## 浪涌保护器

### Output Electrical Parameter Monitoring

- 标配德国DEHN模块式多级浪涌保护器
- 高通流量氧化锌压敏电阻，高放电性能
- 采用3+1保护模式，可适用于比较恶劣的电力环境
- “动态热脱扣”SPD检测装置，可靠性高
- 使用模块释放按钮，更换模块更简便
- Standard configuration includes German DEHN modular multi-stage surge protectors.
- High discharge performance with high-flow zinc oxide varistors.
- Utilizes a 3+1 protection mode, suitable for harsh electrical environments.
- Equipped with "dynamic thermal disconnection" SPD monitoring device for high reliability.
- Features a module release button for easier and more convenient module replacement.



## 技术参数 Technical Parameters

标准 Standard	通过型式试验标准 Pass type test standards	GB/T 7251.12-2013
电气参数 Electrical Parameters	额定工作电压 Rated Operating Voltage	380V
	额定绝缘电压 Rated Insulation Voltage	660V
	额定冲击耐受电压 Rated Impulse Withstand Voltage	6kV
	过电压类别 Overvoltage Category	III
	污染等级 Pollution Degree	3
	额定频率 Rated Frequency	50HZ
	额定电流 Rated Current	32A-630A
	额定短时耐受电流 Rated Short-Time Withstand Current	15kA
环境参数 Environmental Parameters	防护等级 Protection Rating	IP30
	环境温度 Ambient Temperature	-5° C... +40° C
	相对湿度 Relative Humidity	+40°C时不超过50%RH在较低温度时允许有较高的相对湿度，例如+20°C时可达90%RH +40° C at no more than 50% RH, with higher relative humidity allowed at lower temperatures, such as 90% RH at +20° C.
	海拔高度 Altitude	≤2000m
结构特性 Structural Features	其它 Others	非多尘环境，无强烈震动和冲击的场合 Non-dusty environment, free from strong vibrations and impacts
	宽度 ( W ) Width (W)	19英寸 inches ( 482.6mm )
	高度 ( H ) Height (H)	40U (1778mm )
	深度 ( D ) Depth (D)	651.2mm ( 推荐安装于深度大于1000mm机柜 ) 651.2mm (recommended for installation in cabinets with a depth greater than 1000mm)
	框架箱体材料 Frame Material	镀锌钢板SGCC Galvanized steel sheet (SGCC)
	正面面板材料 Front Panel Material	冷轧钢板SPCC Cold-rolled steel sheet (SPCC)
外观颜色 Exterior Color	环氧粉末静电喷涂，RAL9005或RAL7035 Epoxy powder coating, RAL9005 or RAL7035	

## 配置方案 Configuration Plan

型号Model	SP.1216.48	SP.1216.60	SP.1225.48	SP.1225.60	SP.1240.72	SP.1116.24	SP.1116.30
宽度mm Width (mm)	19英寸 19 inches	19英寸 19 inches	19英寸 19 inches	19英寸 19 inches	19英寸 19 inches	19英寸 19 inches	19英寸 19 inches
高度mm Height (mm)	40U	40U	40U	40U	40U	40U	40U
深度mm Depth (mm)	651.2	651.2	651.2	651.2	651.2	651.2	651.2
系统类型 System Type	双路输入 Dual Input	双路输入 Dual Input	双路输入 Dual Input	双路输入 Dual Input	双路输入 Dual Input	单路输入 Single Input	单路输入 Single Input
系统容量 System Capacity	100kVA*2	100kVA*2	160kVA*2	160kVA*2	260kVA*2	100kVA*1	100kVA*1
输入规格 Input Specifications	160A/3P*2	160A/3P*2	250A/3P*2	250A/3P*2	400A/3P*2	160A/3P*1	160A/3P*1
输出规格 Output Specifications	24P*2	30P*2	24P*2	30P*2	36P*2	24P*1	30P*1
浪涌保护 Surge Protection	标配 Standard	标配 Standard	标配 Standard	标配 Standard	标配 Standard	标配 Standard	标配 Standard
监控系统 Monitoring System	标配 Standard	标配 Standard	标配 Standard	标配 Standard	标配 Standard	标配 Standard	标配 Standard
人机界面 Interface	标配 Standard	标配 Standard	标配 Standard	标配 Standard	标配 Standard	标配 Standard	标配 Standard
型号Model	SP.1125.24	SP.1125.30	SP.1125.48	SP.1140.30	SP.1140.48	SP.1140.60	SP.1140.72
宽度mm Width (mm)	19英寸 19 inches	19英寸 19 inches	19英寸 19 inches	19英寸 19 inches	19英寸 19 inches	19英寸 19 inches	19英寸 19 inches
高度mm Height (mm)	40U	40U	40U	40U	40U	40U	40U
深度mm Depth (mm)	651.2	651.2	651.2	651.2	651.2	651.2	651.2
系统类型 System Type	单路输入 Single Input	单路输入 Single Input	单路输入 Single Input	单路输入 Single Input	单路输入 Single Input	单路输入 Single Input	单路输入 Single Input
系统容量 System Capacity	160kVA*1	160kVA*1	160kVA*1	260kVA*1	260kVA*1	260kVA*1	260kVA*1
输入规格 Input Specifications	250A/3P*1	250A/3P*1	250A/3P*1	400A/3P*1	400A/3P*1	400A/3P*1	400A/3P*1
输出规格 Output Specifications	24P*1	30P*1	48P*1	30P*1	48P*1	60P*1	72P*1
浪涌保护 Surge Protection	标配 Standard	标配 Standard	标配 Standard	标配 Standard	标配 Standard	标配 Standard	标配 Standard
监控系统 Monitoring System	标配 Standard	标配 Standard	标配 Standard	标配 Standard	标配 Standard	标配 Standard	标配 Standard
人机界面 Interface	标配 Standard	标配 Standard	标配 Standard	标配 Standard	标配 Standard	标配 Standard	标配 Standard

1. 人机界面标配7英寸电容型触摸屏，分辨率1024\*600，安装于柜体上方，可选配安装于柜体外门上。
2. 精密监控系统监控范围：输入回路及所有输出回路电气参数及开关状态。
3. 浪涌保护器为标准配置：标称放电电流为20kA，最大放电电流40kA。
4. 输出规格为微型断路器，上表数量全部按照P为单位计算，电流规格可选10-63A。
5. 输出规格为常规微型断路器，如需热插拔可换相断路器，需非标询价。

1. The Human-Machine Interface (HMI) comes standard with a 7-inch capacitive touchscreen, with a resolution of 1024\*600, mounted at the top of the cabinet. It can optionally be installed on the outer door of the cabinet.
2. The precision monitoring system covers the monitoring of electrical parameters and switch status for the input circuit and all output circuits.
3. Surge protectors are standard, with a nominal discharge current of 20kA and a maximum discharge current of 40kA.
4. The output specifications use miniature circuit breakers; all quantities in the table are calculated in units of P, with current ratings available from 10A to 63A.
5. The output specifications include conventional miniature circuit breakers. For hot-swappable phase change breakers, non-standard pricing inquiries are required.



## 类型 Type

模块化部件 Modular Components

## 标准尺寸 Standard Size

符合行业标准  
Meet industry standards

## (符合) 标准

Standard(Comply with)

ANSI/EIA,RS-310-D,IEC297-2,  
DIN41494,PART1,DIN41494;  
PART7,ETSI,standard

SPAIO系列作为新一代高度集成的小型微模块数据中心解决方案，以机柜作为机房载体，充分整合UPS、空气调节、配电、防雷、消防（选配）、布线、气流抑制和智能监控等所有子系统，在机柜内部形成一个满足设备安全运行的机房环境，有助于小型机房朝机柜化、标准化方向发展。此外，该系列占地面积小，能在有限的空间之内实现1-3天内的快速部署。

The SPAIO series, as a new generation of highly integrated micro modular data center solutions, uses cabinets as the carrier for data center facilities. It fully integrates all subsystems including UPS, air conditioning, power distribution, surge protection, fire suppression (optional), cabling, airflow management, and intelligent monitoring within the cabinet. This integration creates an environment that ensures the safe operation of equipment, facilitating the development of small data centers towards cabinet-based and standardized solutions. Additionally, this series occupies a small footprint, allowing for rapid deployment within 1-3 days in limited spaces.



## 材料 Material:

SPCC high quality cold-rolled steel  
SPCC优质冷轧钢

## 应用 Application:

Installing server interchanger etc.  
安装服务器交换机等

## 应用场景 Application Scenarios

- SPAIO系列可应用在50平米以下或1负荷25kVA以下的小型机房。
- 适用于区域型、小型商办环境、边缘数据中心的I应用。
- 适用于政府、教育、医疗、大型企业的分支机构的网络间。
- 适用于电信、金融、能源、广电、零售等行业的营业网点。

- The SPAIO series is suitable for small data centers under 50 square meters or with IT loads up to 25kVA.
- It's ideal for regional, small commercial, and edge data center applications.
- Applicable for network spaces in government, education, healthcare, and large enterprise branches.
- Suitable for outlets in the telecommunications, finance, energy, broadcasting, and retail sectors.

## 高适应性 High Adaptability

- 模块化部件、标准化接口、工厂预组装、现场快速部署、弹性灵活、建置周期短、方便随需扩容。
- 占地面积最小0.72m<sup>2</sup>，封闭设计，环境适应能力强，可不需要装修、地板等配套工程，有效降低投入成本。
- 可以在设计、安装、运行后的任何阶段对系统做可用性等级的变化，供电系统、制冷系统等不需重新设计。

- Modular components, standardized interfaces, factory pre-assembly, rapid onsite deployment, flexibility, quick setup, and easy scalability.
- Minimal footprint of 0.72m<sup>2</sup>, strong environmental adaptability, no need for additional constructions, reducing costs.
- System availability can be adjusted at any stage without needing to redesign power or cooling systems.

## 高效性 High Efficiency

- 封闭冷/热通道隔离设计，避免气体混流、冷量损失，大幅提高回风温度、制冷效率，降低PUE值。
- 机架式精密空调采用直流变频压缩机和无极调速EC风机，能效比≥3.1。
- 选用高频机架式UPS或机架式模块化UPS，输入功率因数≥0.99,10KVA以上最高效率≥95%。

- Enclosed cold/hot aisle design improves cooling efficiency and reduces PUE by preventing air mixing and cooling loss.
- Rack-mounted precision AC features DC variable frequency compressors and EC fans, achieving an EER of ≥3.1.
- Uses high-frequency or modular rack-mounted UPS with an input power factor of ≥0.99 and efficiencies up to 95% for units over 10KVA.

## 高可靠性 High Reliability

- 采用机械结构，当检测到温度过高等信息时直接打开散热系统，无需UPS供电提高供电系统可靠性，不占用UPS供电资源。
- 关键部件可按需采用N、N+1、2N或2(N+1)设计满足客户高可靠要求。
- 分布式控制提高可靠性，空调、UPS、环境、智能机柜（温湿度、照明、PDU、门磁采集）等采用分布控制系统，即便其中一个控制器故障，亦不影响其他设备信息正常显示及上传。
- Mechanical structure automatically activates cooling when high temperatures are detected, improving power system reliability without using UPS resources.
- Critical components offer designs such as N, N+1, 2N, or 2(N+1) to meet high reliability requirements.
- Distributed control enhances reliability; systems like AC, UPS, and smart cabinets use independent controls, preventing a single controller failure from affecting other systems.

项目 Project	描述 Description	SAIO-1		
整体参数 Overall Parameters	输入电源 Input Power	220Vac,50Hz,1ph+N+PE		
	工作温度 Operating Temperature	5~30℃		
	湿度范围 Humidity Range	10~90%		
机柜系统 Cabinet System	机柜尺寸 Cabinet Dimensions	WHD=600*2000*1200		
	可用空间 Usable Space	31U		
散热系统 Cooling System		4.2kW机架式空调 (5U) 4.2kW Rack-Mounted Air Conditioner (5U)		
配电系统 Power Distribution System	UPS	容量 Capacity	3kVA	
		安装方式 Installation Method	机架式安装 Rack Mount	
		安装高度 Installation Height	2U	
	电池 Battery		选配电池包 Optional Battery Pack	
		配电盒 Distribution Box	安装方式 Installation Method	机架式安装 Rack Mount
			防雷 Lightning Protection	C级 Class C
			维修旁路 Maintenance Bypass	标配 Standard Configuration
	PDU	安装方式 Installation Method	竖装 Vertical Installation	
		类型 Type	20*10A+4*16A	
		温度湿度传感器 Temperature and Humidity Sensor	标配 Standard Configuration	
监控系统 Monitoring System	监控采集器 Monitoring Collector	标配 Standard Configuration		
	触摸屏 Touch Screen	标配 Standard Configuration		
	烟感 Smoke Detector	标配 Standard Configuration		
	水浸 Water Leak Detector	标配 Standard Configuration		
	门磁 Door Magnet	标配 Standard Configuration		
	门状态 Door Status	标配 Standard Configuration		
负载功率段 Reactive Power		2.4kW		



项目 Project	描述 Description	SAIO-1F		
整体参数 Overall Parameters	输入电源 Input Power	220Vac,50Hz,1ph+N+PE		
	工作温度 Operating Temperature	5~30℃		
	湿度范围 Humidity Range	10~90%		
机柜系统 Cabinet System	机柜尺寸 Cabinet Dimensions	WHD=600*2000*1200		
	可用空间 Usable Space	36U		
散热系统 Cooling System		顶置风扇 Top-mounted Fan		
配电系统 Power Distribution System	UPS	容量 Capacity	3kVA	
		安装方式 Installation Method	机架式安装 Rack Mount	
		安装高度 Installation Height	2U	
	电池 Battery		选配电池包 Optional Battery Pack	
		配电盒 Distribution Box	安装方式 Installation Method	机架式安装 Rack Mount
			防雷 Lightning Protection	C级 Class C
			维修旁路 Maintenance Bypass	标配 Standard Configuration
	PDU	安装方式 Installation Method	竖装 Vertical Installation	
		类型 Type	20*10A+4*16A	
		温度湿度传感器 Temperature and Humidity Sensor	标配 Standard Configuration	
监控系统 Monitoring System	监控采集器 Monitoring Collector	标配 Standard Configuration		
	触摸屏 Touch Screen	标配 Standard Configuration		
	烟感 Smoke Detector	标配 Standard Configuration		
	水浸 Water Leak Detector	标配 Standard Configuration		
	门磁 Door Magnet	标配 Standard Configuration		
	门状态 Door Status	标配 Standard Configuration		
负载功率段 Reactive Power		2.4kW		



项目 Project	描述 Description	SAIO-2	
整体参数 Overall Parameters	输入电源 Input Power	220Vac,50Hz,1ph+N+PE	
	工作温度 Operating Temperature	5~30°C	
	湿度范围 Humidity Range	10~90%	
机柜系统 Cabinet System	机柜尺寸 Cabinet Dimensions	WHD=1200*2000*1200	
	可用空间 Usable Space	28U+42U=70U	
散热系统 Cooling System		8kW机架式空调 8kW Rack-Mounted Air Conditioner	
配电系统 Power Distribution System	UPS	容量 Capacity	6kVA
		安装方式 Installation Method	机架式安装 Rack Mount
		安装高度 Installation Height	2U
	电池 Battery		选配电池包 Optional Battery Pack
		配电箱 Distribution Box	安装方式 Installation Method
	防雷 Lightning Protection		C级 Class C
	维修旁路 Maintenance Bypass		标配 Standard Configuration
	安装高度 Installation Height		4U
	PDU	安装方式 Installation Method	竖装 Vertical Installation
		类型 Type	(20*10A+4*16A)*2
监控系统 Monitoring System	监控采集器 Monitoring Collector	标配 Standard Configuration	
	触摸屏 Touch Screen	标配 Standard Configuration	
	温湿度传感器 Temperature and Humidity Sensor	标配 Standard Configuration	
	烟感 Smoke Detector	标配 Standard Configuration	
	水浸 Water Leak Detector	标配 Standard Configuration	
	门磁 Door Magnet	标配 Standard Configuration	
	门状态 Door Status	标配 Standard Configuration	
负载功率段 Reactive Power		4.8kW	



项目 Project	描述 Description	SAIO-3	
整体参数 Overall Parameters	输入电源 Input Power	220Vac,50Hz,1ph+N+PE	
	工作温度 Operating Temperature	5~30°C	
	湿度范围 Humidity Range	10~90%	
机柜系统 Cabinet System	机柜尺寸 Cabinet Dimensions	WHD=1800*2000*1200	
	可用空间 Usable Space	42U+28U+42U=112U	
散热系统 Cooling System		8kW机架式空调 8kW Rack-Mounted Air Conditioner	
配电系统 Power Distribution System	UPS	容量 Capacity	10kVA
		安装方式 Installation Method	机架式安装 Rack Mount
		安装高度 Installation Height	2U
	电池 Battery		选配电池包 Optional Battery Pack
		配电箱 Distribution Box	安装方式 Installation Method
	防雷 Lightning Protection		C级 Class C
	维修旁路 Maintenance Bypass		标配 Standard Configuration
	安装高度 Installation Height		4U
	PDU	安装方式 Installation Method	竖装 Vertical Installation
		类型 Type	(20*10A+4*16A)*3
监控系统 Monitoring System	监控采集器 Monitoring Collector	标配 Standard Configuration	
	触摸屏 Touch Screen	标配 Standard Configuration	
	温湿度传感器 Temperature and Humidity Sensor	标配 Standard Configuration	
	烟感 Smoke Detector	标配 Standard Configuration	
	水浸 Water Leak Detector	标配 Standard Configuration	
	门磁 Door Magnet	标配 Standard Configuration	
	门状态 Door Status	标配 Standard Configuration	
负载功率段 Reactive Power		7.5kW	



项目 Project	描述 Description	SAIO-4	
整体参数 Overall Parameters	输入电源 Input Power	380Vac,50Hz,3ph+N+PE	
	工作温度 Operating Temperature	5~30°C	
	湿度范围 Humidity Range	10~90%	
机柜系统 Cabinet System	机柜尺寸 Cabinet Dimensions	WHD=2400*2000*1200	
	可用空间 Usable Space	140U	
散热系统 Cooling System		8kW机架式空调*2 8kW Rack-Mounted Air Conditioner*2	
配电系统 Power Distribution System	UPS	容量 Capacity	20kVA
		安装方式 Installation Method	机架式安装 Rack Mount
		安装高度 Installation Height	6U
	电池 Battery		选配电池包 Optional Battery Pack
		配电箱 Distribution Box	安装方式 Installation Method
	防雷 Lightning Protection		C级 Class C
	维修旁路 Maintenance Bypass		标配 Standard Configuration
	安装高度 Installation Height		6U
	PDU	安装方式 Installation Method	竖装 Vertical Installation
		类型 Type	(20*10A+4*16A)*4
监控系统 Monitoring System	监控采集器 Monitoring Collector	标配 Standard Configuration	
	触摸屏 Touch Screen	标配 Standard Configuration	
	温湿度传感器 Temperature and Humidity Sensor	标配 Standard Configuration	
	烟感 Smoke Detector	标配 Standard Configuration	
	水浸 Water Leak Detector	标配 Standard Configuration	
	门磁 Door Magnet	标配 Standard Configuration	
	门状态 Door Status	标配 Standard Configuration	
负载功率段 Reactive Power		15kW	

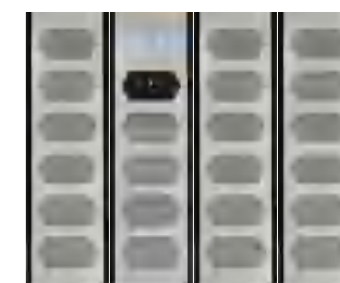

项目 Project	描述 Description	SAIO-5	
整体参数 Overall Parameters	输入电源 Input Power	380Vac,50Hz,3ph+N+PE	
	工作温度 Operating Temperature	5~30°C	
	湿度范围 Humidity Range	10~90%	
机柜系统 Cabinet System	机柜尺寸 Cabinet Dimensions	WHD=3000*2000*1200	
	可用空间 Usable Space	182U	
散热系统 Cooling System		8kW机架式空调*2 8kW Rack-Mounted Air Conditioner*2	
配电系统 Power Distribution System	UPS	容量 Capacity	20kVA
		安装方式 Installation Method	机架式安装 Rack Mount
		安装高度 Installation Height	6U
	电池 Battery		选配电池包 Optional Battery Pack
		配电箱 Distribution Box	安装方式 Installation Method
	防雷 Lightning Protection		C级 Class C
	维修旁路 Maintenance Bypass		标配 Standard Configuration
	安装高度 Installation Height		6U
	PDU	安装方式 Installation Method	竖装 Vertical Installation
		类型 Type	(20*10A+4*16A)*5
监控系统 Monitoring System	监控采集器 Monitoring Collector	标配 Standard Configuration	
	触摸屏 Touch Screen	标配 Standard Configuration	
	温湿度传感器 Temperature and Humidity Sensor	标配 Standard Configuration	
	烟感 Smoke Detector	标配 Standard Configuration	
	水浸 Water Leak Detector	标配 Standard Configuration	
	门磁 Door Magnet	标配 Standard Configuration	
	门状态 Door Status	标配 Standard Configuration	
负载功率段 Reactive Power		15kW	



# IP AND IK CLASSIFICATIONS

## IP、IK 防护等级标准



First Number	防固形物	Second Number	防水	IK	防物理冲击
IP	Protection	IP	Protection	IK	Test
0	无防护 No protection		无防护 No protection		无防护 No protection
1	防护50mm直径和更大的固体外来体 protected against solid objects up to 50 mm e.g. to 50 mm e.g. hands		防护垂直落下的水滴 protected against vertically falling drops of water	-	冲击 <1 焦耳 impact <1 joule
2	防护12.5mm直径和更大的固体外来体 protected against solid objects up to 12.5 mm e.g. fingers		箱体倾斜15°时，防护垂直落下的水滴 protected against direct sprays of water up to 15° from the vertical		1焦耳冲击 impact 1 joule
3	防护2.5mm直径和更大的固体外来体 protected against solid objects over 2.5mm (tools+small wires)		防护以60°角从垂直线两侧溅出的水 protected against water sprayed from all directions-limited ingress permitted		2焦耳冲击 impact 2 joule
4	防护1.0mm直径和更大的固体外来体 protected against solid objects over 1mm (tools+small wires)		防护从每个方向对准箱体的溅水 protected against water sprayed from all directions-limited ingress permitted		5焦耳冲击 impact 5 joule
5	防护灰尘 protected against dust limited ingress permitted (no harmful deposit)		防护从每个方向对准箱体的低压喷水 protected against low pressure jets of water from all directions-limited ingress permitted		10焦耳冲击 impact 10 joule
6	灰尘封闭 totally protected against dust		防护从每个方向对准箱体的高压喷水 protected against strong jets of water e.g. for use on shipdecks-limited ingress permitted		20焦耳冲击 impact 20 joule
			防护在15cm~1m深水浸入30分钟 protected against the effects of immersion between 15 cm and 1m		
			防护长时间浸入水中 protected against long periods of immersion under pressure		

# TECHNICAL INFORMATION

## 技术信息



NEMA 防护等级 NEMA protection level					
NEMA防护等级 NEMA protection level	IP-保护种类 IP-protection type	内部范围 Internal scope	外部范围 Outer scope	内部和外部范围 Internal and external scope	防护: Protection:
NEMA 1	IP 23	■			防护垂直下落 Protection against vertical drops
NEMA 2	IP 30	■			喷水和灰尘 Water spray and dust
NEMA 3	IP 64		■		风尘，灰尘和冰雹 Wind dust, dust and hail
NEMA 3R	IP 32		■		下雨和结冰 Rain and icing
NEMA 3S	IP 64		■		如3，设备也适用于室外和结冰状态下 Such as 3, the equipment is also suitable for outdoor and icy conditions
NEMA 4	IP 66			■	如3，防护喷水束和结冰 Such as 3, protection against water spray and icing
NEMA 4X	IP 66			■	如4,防护结冰和腐蚀 Such as 4, protection against icing and corrosion
NEMA 6	IP 66-68			■	如6P,防护结冰和腐蚀 Such as 6P, protection against icing and corrosion
NEMA 6P	IP 67-68			■	短期浸水 Short-term flooding
NEMA 12, 12K	IP 65	■			灰尘和带不带腐蚀的喷水束 Dust and water jet without corrosion
NEMA 13	IP 65	■			如12，防护油和带不带防腐的冷却剂 Such as 12, protective oil and no anti-corrosion coolant

NEMA (National Electrical Manufacturers Association) 是美国电子工业标准机构。根据NEMA的明细表和测试方法Underwriters Laboratories (UL) 对我们提供的箱体进行测试。以上的表格是NEMA的保护等级与相应的IP-防护种类。

NEMA (National Electrical Manufacturers Association) is the American Electronics Industry Standards Agency. According to the NEMA schedule and test method Underwriters Laboratories (UL), the cabinets we provide are tested. The above table is the protection level of NEMA and the corresponding IP-protection type.

材料特性一览表  
LIST OF MATERIAL PROPERTIES

	PC	ABS	聚酯纤维 Polyester	铝 aluminum	AISI304不锈钢 AISI304 stainless steel	AISI316不锈钢 AISI316 stainless steel	粉末涂层钢 Powder coated steel
室外 outdoor	●●●●	●●	●●●●●	●●●●	●●●●●	●●●●●	●●●●
室内 indoor	●●●●●	●●●●●	●●●●●	●●●●●	●●●●●	●●●●●	●●●●●
成本 cost	●●●●	●●●●●	●●	●●●	●	●	●●
重量 weight	●●●●●	●●●●●	●●	●	●	●	●
硬度 hardness	●●●	●●	●●●●	●●●●	●●●●●	●●●●●	●●●●●
抗冲击 Impact resistance	●●●●	●●	●●●●	●●●●	●●●●●	●●●●●	●●●●●
抗紫外线 anti-UV	●●●●	●	●●●●	●●●●●	●●●●●	●●●●●	●●●●●
温度范围 temperature range	●●●●	●●	●●●●	●●●●	●●●●	●●●●	●●●●
加工难易度 Processing difficulty	●●●●●	●●●●●	●	●	●	●	●●
绝缘性 Insulation	●●●●●	●●●●●	●●●●	K/A	K/A	K/A	K/A
防火性能 Fire performance	●●●●	●	●	●●●●	●●●●●	●●●●●	●●●●●
抗溶剂 Anti-solvent	●	●	●●●●●	●●●●●	●●●●●	●●●●●	●
抗汽油 Gasoline resistant	●●●	●	●●●●●	●●●●●	●●●●●	●●●●●	●
抗高压流体 Resistant to high pressure fluids	●●●●●	●●●●●	●●●●●	●●●●●	●●●●●	●●●●●	●●
抗酒精 Anti-alcohol	●●●●	●●●	●●●●	●●●●●	●●●●●	●●●●●	●●
抗碱性 Alkaline resistance	●●	●●●●●	●●●●	●	●●●●●	●●●●●	●
抗酸性 Acid resistance	●●●	●●	●●●	●	●●●●	●●●●●	●

●●●●● 极好 Excellent    ●●●●/●●● 好 good    ●● 中等 medium    ● 较差 Poor    K/A 无法使用 Not available

聚碳酸酯 ( PC ) Polycarbonate (PC)	
+高抗冲击强度 +High impact strength	-由于加入玻纤, 达到正确的色度非常困难 -Due to the addition of glass fiber, it is very difficult to achieve the correct chromaticity
+高防护等级 +High protection level	
+重量轻 + Light weight	
+化学稳定性高 +High chemical stability	
+适用温度范围大 +Large applicable temperature range	
+燃烧后会自熄 + It will automatically extinguish after burning	
+加工性好 +Good processability	
+绝缘性好 +Good insulation	
+可用于室外 + Can be used outdoors	
+可配透明盖 +Can be equipped with transparent cover	

工程塑料 ( ABS ) Engineering Plastics (ABS)	
+价廉物美 +Cheap and good quality	-抗冲击强度能力低于PC -Impact resistance is lower than PC
+重量轻 +Light weight	-抗温度影响能力低于PC -Resistance to temperature influence is lower than PC
+化学稳定性高 + High chemical stability	-抗紫外线能力差 -Poor UV resistance
+能用常用工具加工 +Can be processed with common tools	-不适用于户外 -Not suitable for outdoor use
	-不会自动熄灭火 -Won't turn off automatically

聚酯 ( GRP, 玻纤加强的聚酯 ) Polyester (GRP, glass fiber reinforced polyester)	
+耐温性好 +Good temperature resistance	-加工困难 -Difficulty in processing
+高抗冲击强度 +High impact strength	-不能回收再利用 -Can not be recycled
+防腐性强 + Strong corrosion resistance	
+与多种溶剂的化学稳定性高 +High chemical stability with various solvents	
+适用于高要求工业环境 +Suitable for demanding industrial environments	

铝 ( AL ) Aluminum (AL)	
+比钢质轻 +Lighter than steel	-价格比热塑性材料贵 -More expensive than thermoplastic materials
+很高抗冲击强度 +Very high impact strength	
+与多种溶剂的化学稳定性高 + High chemical stability with various solvents	
+很高的抗温度性能 +Very high temperature resistance	
+很高的防腐性能 +High corrosion resistance	

涂酯钢 ( DC01 AM ) Ester coated steel (DC01 AM)	
+很高抗冲击强度 +Very high impact strength	-易腐蚀 -Easy to corrode
+高防护等级 +High protection level	
+很高的抗温度性能 +Very high temperature resistance	
+易满足客户特殊尺寸要求定制 + Easy to meet customer's special size requirements and customization	

不锈钢 ( AISI 304 ) Stainless steel (AISI 304)	
+高抗冲击强度 +High impact strength	-比涂酯钢难以定制加工 -More difficult to custom process than ester-coated steel
+高防护等级 +High protection level	
+防腐性能强 +Strong anti-corrosion performance	
+抗紫外线能力强 +Strong UV resistance	
+可用于室外, 建议遮盖防雨 +Can be used outdoors, it is recommended to cover and prevent rain	
+适用于工业环境 +Suitable for industrial environment	
+非常适用于食品加工工业 +Very suitable for the food processing industry	

防酸钢 ( AISI 316 ) Acid-proof steel (AISI 316)	
具有不锈钢 ( AISI 304 ) 的所有优点, 以及: Has all the advantages of stainless steel (AISI 304), as well as:	
+很高的防腐性能 +High corrosion resistance	
+非常适用于海上作业环境 +Very suitable for offshore working environment	
+非常适用于造纸业 +Very suitable for the paper industry	

# RAL COLOR CARD

## RAL色卡



RAL1000 Green beige 米绿色	RAL1001 Beige 米色, 淡黄或灰黄	RAL1002 Sand yellow 沙黄色	RAL1003 Signal yellow 信号黄	RAL1004 Goldenyellow 金黄色	RAL1005 Honey yellow 蜜黄色	RAL1006 Maize yellow 玉米黄	RAL1007 Daffodil yellow 灰黄色	RAL1011 Brown beige 米褐色
RAL1012 Lemon yellow 柠檬黄	RAL1013 Oyster white 牡蛎白	RAL1014 Ivory 象牙色	RAL1015 Light ivory 浅象牙色	RAL1016 Sulfur yellow 硫磺色	RAL1017 Saffron yellow 橘黄色	RAL1018 Zinc yellow 锌黄色	RAL1019 Grey beige 米灰色	RAL1020 Olive yellow 橄榄黄
RAL1021 Rape yellow 油菜黄	RAL1023 Traffic yellow 交通黄	RAL1024 Ochre yellow 赭黄色	RAL1026 Luminous yellow 荧光黄	RAL1027 Curry 咖喱色	RAL1028 Melon yellow 瓜黄色	RAL1032 Broom yellow 金雀花黄	RAL1033 Dahlia yellow 大丽花黄	RAL1034 Pastel yellow 粉彩黄
RAL1035 (金属漆) Pearl beige 珍珠米	RAL1036 (金属漆) Pearl gold 珍珠金	RAL1037 Sun yellow 太阳黄	RAL2000 Yellow orange 黄橙色	RAL2001 Red orange 红橙色	RAL2002 Vermillion 朱红色	RAL2003 Pastel orange 粉彩橙	RAL2004 Pure orange 纯橙色	RAL2005 Luminous orange 荧光橙
RAL2007 Leuchthellorange 荧光亮橙	RAL2008 Bright red orange 亮红橙	RAL2009 Traffic orange 交通橙	RAL2010 Somgnal orange 信号橙	RAL2011 Deep orange 深橙色	RAL2012 Salmon orange 鲑鱼橙	RAL2013 (金属漆) Pearl orange 珍珠橙	RAL3000 Flame red 火焰红	RAL3001 Signal red 信号红
RAL3002 Carmine red 胭脂红	RAL3003 Ruby red 宝石红	RAL3004 Purple red 紫红色	RAL3005 Wine red 葡萄酒红	RAL3007 Black red 黑红色	RAL3009 Oxide red 氧化红	RAL3011 Brown red 棕红色	RAL3012 Beige red 米红色	RAL3013 Tomato red 番茄红
RAL3014 Antique pink 古旧粉	RAL3015 Light pink 淡粉色	RAL3016 Coral red 珊瑚红色	RAL3017 Rose 玫瑰色	RAL3018 Strawberry red 草莓红	RAL3020 Traffic red 交通红	RAL3022 Salmon pink 鲑鱼粉	RAL3024 Luminous red 荧光红	RAL3026 Luminous bright red 荧光亮红
RAL3027 Raspberry red 树莓红	RAL3031 Orient red 戈亚红色	RAL3032 (金属漆) Pearl ruby red 珍珠宝石红	RAL3033 (金属漆) Pearl pink 珍珠粉	RAL4001 Red lilac 红丁香紫	RAL4002 Red violet 红紫色	RAL4003 Heather violet 石南紫	RAL4004 Claret violet 酒红紫	RAL4005 Blue lilac 蓝丁香紫
RAL4006 Traffic purple 交通紫	RAL4007 Purple violet 罗兰紫	RAL4008 Signal violet 信号紫	RAL4009 Pastel violet 粉彩紫	RAL4010 etemagenta 电信紫	RAL4011 (金属漆) Pearl violet 珍珠紫	RAL4012 (金属漆) Pearl blackberry 珍珠黑莓紫	RAL5000 Violet blue 紫蓝色	RAL5001 Green blue 绿蓝色
RAL5002 Ultramarine blue 群青蓝	RAL5003 Sapphire blue 蓝宝石	RAL5004 Black blue 黑蓝色	RAL5005 Signal blue 信号蓝	RAL5007 Brillant blue 亮蓝色	RAL5008 Grey blue 灰蓝色	RAL5009 Azure blue 天青蓝	RAL5010 Gentian blue 龙胆蓝	RAL5011 Steel blue 钢蓝色
RAL5012 Light blue 淡蓝色	RAL5013 Cobalt blue 钴蓝色	RAL5014 Pigeon blue 鸽蓝色	RAL5015 Sky blue 天蓝色	RAL5017 Traffic blue 交通蓝	RAL5018 Turquoise blue 绿松石蓝	RAL5019 Capri blue 卡普里蓝	RAL5020 Ocean blue 海洋蓝	RAL5021 Water blue 水蓝色
RAL5022 Night blue 夜蓝色	RAL5023 Distant blue 深邃蓝	RAL5024 Pastel blue 粉彩蓝	RAL5025 (金属漆) Pearl gentian blue 珍珠龙胆蓝	RAL5026 (金属漆) Pearl night blue 珍珠夜蓝	RAL6000 Patina green 铜绿色	RAL6001 Emerald greet 翠绿色	RAL6002 Leaf green 叶绿色	RAL6003 Olive green 橄榄绿

# RAL COLOR CARD

## RAL色卡



RAL6004 Blue green 蓝绿色	RAL6005 Moss green 苔藓绿	RAL6006 Grey olive 灰橄榄绿	RAL6007 Bottle green 瓶绿色	RAL6009 Fir greet 冷杉绿	RAL6010 Grass greet 草绿色	RAL6011 Reseda green 灰绿色	RAL6012 Black green 墨绿色	RAL6013 Reed green 芦苇绿
RAL6014 Yellow olive 黄橄榄绿	RAL6015 Black olive 黑橄榄绿	RAL6016 Turquoise green 松石绿	RAL6017 May green 五月绿	RAL6018 Yellow green 黄绿色	RAL6019 Pastel green 粉彩绿	RAL6020 Ming Green 铬绿色	RAL6021 Light green 苍白绿	RAL6022 Olive drab 橄榄土褐色
RAL6024 Traffic green 交通绿	RAL6025 Fern green 蕨绿色	RAL6026 Opal green 蛋白石绿	RAL6027 Light green 淡绿色	RAL6028 Pine green 松绿色	RAL6029 Mint green 薄荷绿	RAL6032 Signal greet 信号绿	RAL6033 Mint turquoise 薄荷蓝绿	RAL6034 Pastel Turquoise 粉彩蓝绿
RAL6035 (金属漆) Pearl green 珍珠绿	RAL6036 (金属漆) Pearl opal green 珍珠蛋白石绿	RAL7000 Gray squirrel 松鼠灰	RAL7001 Silver 银灰色	RAL7002 Olive gray-green 橄榄灰	RAL7003 Moss grey 苔藓灰	RAL7004 Signal grey 信号灰	RAL7005 Mouse grey 鼠灰色	RAL7006 Mgray 米灰色
RAL7008 Khakigrey 卡其灰	RAL7009 Green grey 绿灰色	RAL7010 Tarpaulin grey 油布灰	RAL7011 Iron grey 铁灰色	RAL7012 Basaltic lime 玄武岩灰	RAL7013 Brown grey 棕灰色	RAL7015 Slate grey 板岩灰	RAL7016 Anthracite grey 煤灰色	RAL7021 Black grey 黑灰色
RAL7022 Umbr grey 暗灰色	RAL7023 Concrete grey 混凝土灰	RAL7024 Graphite grey 石墨灰	RAL7026 Granite grey 花岗岩灰	RAL7030 Stone grey 石灰色	RAL7031 Blue grey 蓝灰色	RAL7032 Pebble grey 卵石灰	RAL7033 Cement grey 水泥灰	RAL7034 Yellow grey 黄灰色
RAL7035 Light grey 浅灰色	RAL7036 Platinum grey 铂金灰	RAL7037 Dustgrey 土灰色	RAL7038 Agate grey 玛瑙灰	RAL7039 Quartz grey 石英灰	RAL7040 Window grey 窗灰色	RAL7042 Traffic grey A 交通灰A	RAL7043 Traffic grey B 交通灰B	RAL7044 Silk grey 丝灰色
RAL7045 Telegrey 1 电信灰1	RAL7046 Telegrey 2 电信灰2	RAL7047 Telegrey 4 电信灰4	RAL7048 (金属漆) Pearl mouse grey 珍珠鼠灰	RAL8000 Green brown 绿棕色	RAL8001 Ochre brown 赭石棕	RAL8002 Signal brown 信号棕	RAL8003 Brown soil 土棕	RAL8004 Coper brown 铜棕色
RAL8007 Brown Deer 鹿棕色	RAL8008 Olive brown 橄榄棕	RAL8011 Dark brown 深棕色	RAL8012 Red brown 红棕色	RAL8014 Sepia brown 乌贼棕	RAL8015 Su Brown 栗棕色	RAL8016 Mahogany brown 桃花心木褐	RAL8017 Chocolate brown 巧克力棕色	RAL8019 Grey brown 灰棕色
RAL8022 Black brown 黑棕色	RAL8023 Orange brown 橙棕色	RAL8024 Serge Brown 米黄棕	RAL8025 Pale brown 苍白棕	RAL8028 Tra brown 大地棕	RAL8029 (金属漆) Pearl copper 珍珠铜棕	RAL9001 Cream 奶油黄	RAL9002 Grey white 灰白色	RAL9003 Signal white 信号白
RAL9004 Signal black 信号黑	RAL9005 Black ink 墨黑色	RAL9006 White aluminium 白铝色	RAL9007 Grey aluminium 灰铝色	RAL9010 Pure white 纯白色	RAL9011 Graphite Black 石墨黑	RAL9016 Traffic white 交通白	RAL9017 Traffic black 交通黑	RAL9018 Papyrus white 草纸白
RAL9022 (金属漆) Pearl light grey 珍珠浅灰	RAL9023 (金属漆) Pearl dark grey 珍珠深灰							